

# BONENG



0.25kW~3kW

S斜齿蜗轮齿轮马  
达变频驱动一体机

S Helical-Worm  
Gearmotor Variable  
Frequency Drive  
All-in-one

Edit date 04/2023  
Selection Catalogue: C05.0054-CN/EN

## Boneng Transmission



控制器/驱动器/马达/  
齿轮马达/齿轮箱

Controller/ Drive/ Motor/  
Gearmotor/ Gearbox

## 选型注意事项:

- ◆ 结构示意图、外形图及其他附图只属范例，无严格比例要求。（未注尺寸单位均为mm）。
- ◆ 所注重量仅为平均值，并不具有约束力。
- ◆ 注油量只作为参考值，实际注油量应以油镜上的标记为准。

## ⚠ 使用注意事项

- ◆ 为防止意外事故发生，所有旋转部件均按照使用者所在国家和地区的安全规范由购置方加罩保护。
- ◆ 试车之前必须认真阅读使用说明书。
- ◆ 齿轮马达在供货时已处于准运行状态，运行前需加注润滑油。
- ◆ 齿轮马达应由熟悉相关安全要求的专业人员安装；安装时必须要有安全装置以防止事故发生，安装位置必须符合规定。

## Note:

- ◆ The structure scheme, appearance diagram and other attached diagrams in sample are examples, there is no strict proportion requirement. (The unmarked dimension units are mm).
- ◆ The marked weight is average value, it has no constraint force.
- ◆ The marked oil quantity in sample is only reference value, actual oil filling quantity should be the same with the mark on oil immersion lens.

## ⚠ You must confirm to the following instructions

- ◆ To prevent accidents, all the rotation parts are added with protective covers according to the safety regulations of the nation and region.
- ◆ Before debugging, you should carefully read instruction book.
- ◆ Gearmotor is on running-permission status when delivered, you should add lubrication oil before putting it into running.
- ◆ The gearmotor should be installed by technical staffs who could be familiar with corresponding security requirements. Security device should be required for preventing from accidents while installation position must be satisfied with regulations.

# 目录

# Contents

01.概述 .....	01	01.Overview .....	01
02.产品特性 .....	01	02.Characteristics .....	01
03.优势特点 .....	04	03.Advantages .....	04
04.型号表示方法 .....	05	04.Type Designation .....	05
05.传动能力表 .....	07	05.Transmission Capacity .....	07
06.外形尺寸图 .....	15	06.Dimensions .....	15
07.允许的输出轴径向力表 .....	27	07.Permissible Radial Force of Output Shaft .....	27
08.被驱动轴推荐尺寸 .....	28	08.Recommended Dimensions for Driven Equipment Shaft .....	28
09.轴端中心孔尺寸 .....	30	09.Dimensions of Shaft End Centre Hole .....	30
10.平键与键槽的尺寸 .....	31	10.Dimension of Parallel Key and Keyway .....	31
11.可选附件和指定配置 .....	32	11.Accessories and Specific Configuration .....	32
12.润滑油 .....	33	12.Oil .....	33
13.重量表 .....	33	13.Weight .....	33

## 1.概述

齿轮马达变频驱动一体机是基于分布式应用的齿轮马达、驱动器一体式产品，搭配全封闭自扇冷却三相交流异步马达，设计生产符合ISO、IEC、GB等相关标准的要求。适用于连续工作制(S1)、恒转速或一定速度范围内的变频调速应用，同时也满足大部分断续工作方式(S2-S10)。

该一体机系统专门针对输送带、分拣系统、行李和货物运输系统、仓库和配送物流、邮件分拣以及包裹配送等应用中的节能和成本效益水平运动进行了优化。可广泛应用于多机水平输送等行业，以及对防护等级有较高要求的电气传动场合。

## 2.产品特性

### 2.1.技术特性

- ◆ 颜色：银色RAL9006
- ◆ 马达额定功率：0.25kW~3kW；
- ◆ 马达极数：4；
- ◆ 马达效率：达到GB18613-2020标准能效等级3级，且满足IEC 60034-30标准中的IE2和IE3效率等级；
- ◆ 马达防护等级：防护等级为IP55；
- ◆ 马达绝缘等级：绝缘系统按155°C (F) 温度等级设计，按130°C (B) 温度等级考核；
- ◆ 马达冷却方式：马达标准冷却方式为IC411自扇冷却。
- ◆ 支持SVC(开环矢量)控制、VF控制
- ◆ 可实现速度控制与转矩控制
- ◆ 支持Modbus通讯、EtherCAT通讯
- ◆ 支持本地上位机连接

### 2.2.运行环境

- ◆ 高度不超过海拔1000m；
- ◆ 允许的环境温度在-20°C ~ 40°C；
- ◆ 所允许的相对湿度：
  - 20°C ≤ T ≤ 20°C：100%
  - 20°C < T ≤ 30°C：95%
  - 30°C < T ≤ 40°C：55%

## 1.Overview

Gearmotor variable frequency drive all-in-one is based on distributed application and equipped with totally enclosed fan cooled three-phase asynchronous motor. Its design and production meet the requirements of ISO, IEC, GB and other related standards. The integrated machine is applicable for continuous running duty (S1), constant speed and variable frequency speed control within a specific speed range. Also, it can meet most short-time duty (S2-S10).

The integrated machine system is optimized for energy conservation and cost performance in the field of conveyor belt, automatic sorting systems, baggage and cargo system, warehouse and distribution logistics, mail sorting, parcel delivery and other objects. It is widely used in multi-machine horizontal conveying and other industries, as well as electrical transmission occasions with higher requirements for protection levels.

## 2.Characteristics

### 2.1.Technical characteristics

- ◆ Motor color: silver RAL9006;
- ◆ Rated power: 0.25kW~3kW;
- ◆ Poles of motor:4;
- ◆ Motor efficiency: meet Grade 3 according to GB18613-2020 and IE2, IE3 according to IEC 60034-30
- ◆ Degree of protection : IP55
- ◆ Insulation class: the insulation system is designed for temperature class 155°C(F) and checked by temperature class 130°C(B);
- ◆ Cooling method: self-ventilated (IC411) as standard;
- ◆ Support SVC (open-loop vector) control and VF control;
- ◆ Realize speed control;
- ◆ Support Modbus communication and EtherCAT communication;
- ◆ Support local upper computer connection.

### 2.2.Operating environment

- ◆ Altitude shall not exceed 1000m above seal-level;
- ◆ Allowed temperature between -20°C and 40°C;
- ◆ Permitted relative humidity:
  - 20°C ≤ T ≤ 20°C：100%
  - 20°C ≤ T ≤ 30°C：95%
  - 30°C ≤ T ≤ 40°C：55%

### 2.3.驱动器规格参数

端口参数	
输出电源	外接24V电源 ● 24VDC±10%, 最大40mA
	外接10V电源 ● +10V-GND, 最大10mA
数字量输入	4通道共COM输入 ● DI0~DI3, 光耦隔离, 支持双向输入
	● 输入电压 12VDC~30VDC
模拟量输入	1通道输入 ● 电压型: DC 0~10V ● 精度1%
LED指示灯	2个双色指示 ● 运行、故障、通信状态指示
通讯端口	RS485通讯 或以太网通讯 ● Modbus RTU 格兰头接口 ● EtherCAT 航空插头
	PC通讯接口 ● RS485通讯, 特制端口 ● 支持PC上位机调试及软件更新

### 2.3 Drive specification parameters

Port parameters	
Output power supply	External 24V power supply ● 24VDC±10%, max. 40mA
	External 10V power supply ● +10V-GND, max. 10mA
Digital input	4 channels COM input ● DI0~DI3, opto-isolator, support bidirectional input
	● Input voltage: 12VDC~30VDC
Analog input	1 channel input ● Voltage type: DC 0~10V ● Precision: 1%
LED indicator	2 two-color indicator lights ● Indication of running, failure and communication status
Communication port	RS485 communication or EtherCAT communication ● ModBus RTU cable gland port ● EtherCAT aviation plug
	PC communication port ● RS485 communication, Special purpose port
	● Support PC uppercomputer debugging and software update

功率参数 (通用参数)	
输入电压	380...480V 3AC ±10%
输入频率	47...63Hz
输出频率	0...300Hz 50Hz不降容, <50Hz参见降容曲线
载波频率	4kHz (标准)
功率因素	0.95
控制器效率	95...97%
过载能力	1.2倍额定输出电流1min, 1.5倍额定输出电流3sec, 周期10min
电磁兼容	可选符合EN 55011 标准的A级和B级滤波器
防护等级	IP55
工作温度	-20...+40℃不降容, >40...60℃, 参见降容曲线
标准SCCR	10kA
保护功能	● 欠电压
	● 过电压
	● 过载
	● 短路
	● 电机失速保护
	● 电机过载
	● 变频器过温

Power parameter (common parameters)	
Input voltage	380~480V, 3AC, ±10%
Input frequency	47~63Hz
Output frequency	0~300Hz (see the derating curve when frequency less than 50Hz)
Carrier frequency	4kHz (standard)
Power factor	0.95
Efficiency of controller	95~97%
Overload capability	1.2 times rated output current for 1min, 1.5 times rated output current for 3 s within a cycle time of 10min
Electromagnetic compatibility	Class A and B filters are available according to EN 55011
Protection grade	IP55
Operating temperature	-20~+40℃: no derating; 40~60℃: see the derating curve
Standard SCCR	10kA
Defensive function	Under voltage
	Over voltage
	Overload
	Short circuit
	Mortor stall protection
	Motor overload
	Inverter over temperature

**2.4.驱动器特性曲线**

电流降容 · 环境温度

**2.4 Drive characteristic curve**

Current derating · environment temperature

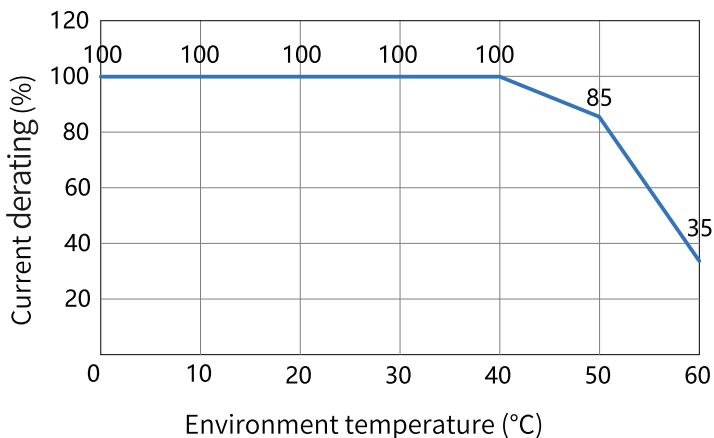

电流降容 · 海拔高度

Current derating · altitude

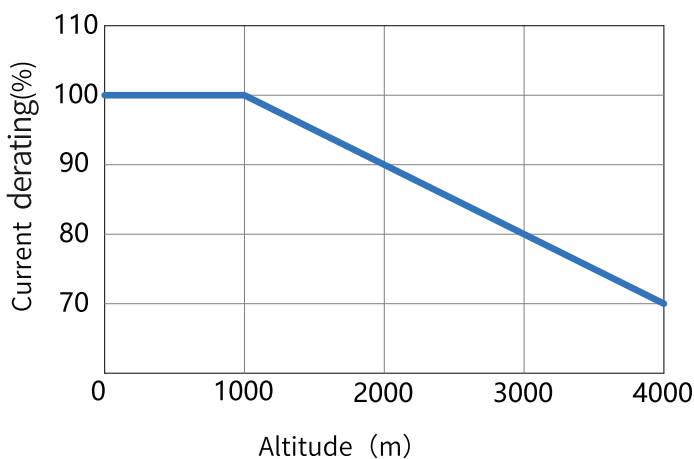

电流降容 · 输出频率

Current derating · output frequency

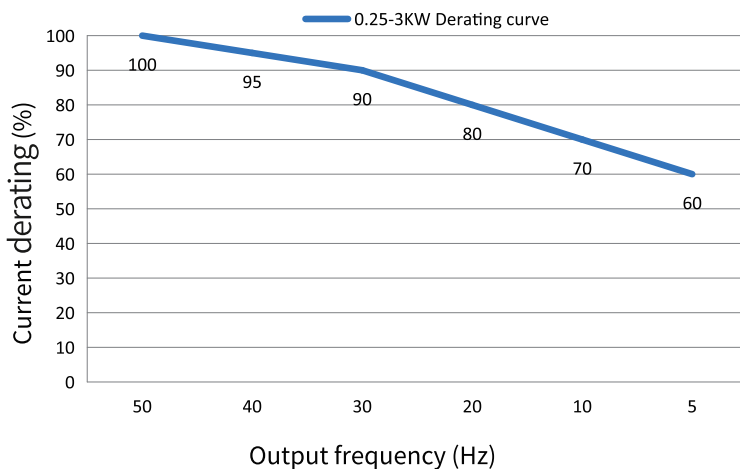

### 3. 优势特点

#### (1) 用户友好

安装灵活	具备多方向进线、多方位安装，匹配客户环境需求
参数拷贝	调试一台驱动器，通过PC软件拷贝到其他驱动器
参数分组	功能码合理分组，参数简单直观，方便理解
支持Boneng Drivesoft 软件	参数显示及修改，虚拟示波器，已修改参数等功能方便调试
选配电位器	带电位器旋钮，实现无极调速

#### (2) 品质可靠

高质量电子元件/电容器	使用寿命更长
所有变频器出厂前进行满负荷测试	可靠性高
完善的驱动器保护功能	平均无故障时间长
带涂层线路板，防潮、防腐蚀外壳	适应更恶劣环境

#### (3) 性能卓越

过程比例积分(PID)控制器	无需外部控制器
自动识别电机模型	发挥电机的全部潜能
随载随速	轻载高速 重载限速 提升工作效率
跟踪启动(跟踪自由旋转的电机)	避免启动冲击
支持参数互联	参数可互联到P组，可实现启停来源，速度来源等选择来自P组参数，极其灵活
支持自由功能块	支持逻辑，算术运算，延时，数据选择，适用特殊工况参数设置

#### (4) 成本节约

由于无需机柜和长距离电机电缆，可以节省成本，且系统设计外观漂亮。

### 3. Advantages

#### (1) User-friendliness

Flexible installation	With multi-directional cable entry and multi-direction installation, it meet the customer environmental requirements
Parameter copy	Debug a drive and copy it to another drive using PC software
Grouping of parameters	Function code is grouped reasonably and parameters are simple and intuitive for understanding
Support Boneng Drivesoft software	Parameter display and modification, virtual oscilloscope, modified parameters and other functions are convenient for debugging
Optional potentiometer	Stepless speed regulation is achieved with potential knob to achieve

#### (2) Reliable quality

High quality electronic components/capacitor	Longer service life
All frequency converters are tested at full load before leaving the factory	high reliability
Complete drive protection function	Longer mean time between failures
Coated circuit board, damp and corrosion proof housing	Adapt to the harsher environment

#### (3) Superior performance

Process proportional integral controller (PID)	No external controller required
Automatic identification of motor models	Develop the full potential of the motor
Following load and speed	Light load with high speed, heavy load with limited speed, thereby improving work efficiency
Trace startup (track freely spinning motors)	Avoid start-up shocks
Support parameter interconnection	The parameters can be interconnected to the P group and realize the parameter selection from the P group such as the start and stop source, the speed source, etc., which is extremely flexible
Support free function modules	Support logic, arithmetic operation, delay, data selection and special working conditions parameter setting

#### (4) Cost saving

Without cabinets and long-distance motor cables, costs are saved and the system design looks great.



## 4.型号表示方法

**系列名**  
**传动级数**  
 2级  
**机座号**  
**安装形式**  
 H=底脚安装  
 F=法兰安装  
 S=小法兰安装  
 A=轴装式安装  
 T=带扭力臂附件安装

**输出形式**  
 A/B/D/E=单向平键实心轴  
 C/F=双向平键实心轴  
 G/H=平键空心轴  
 I/J=锁紧盘空心轴  
 K/L=渐开线花键空心轴

**公称减速比代号**  
**安装方位**  
 D1/D2/D3/D4/D5/D6

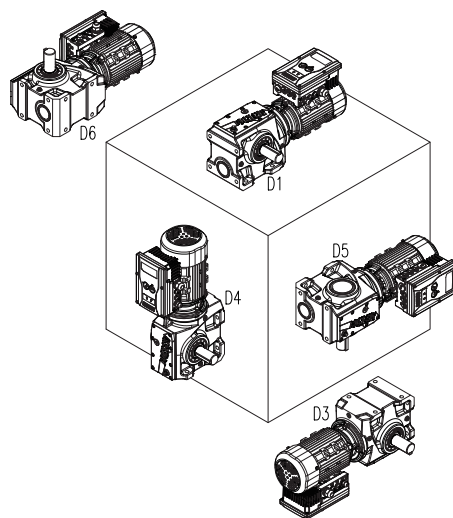

**可选附件和指定配置**  
 0=无可选附件和指定配置  
 6=补偿油箱

**润滑油代号**  
 0=不加润滑油（不加油出厂时，请选此项）  
 4=矿物润滑油VG680（环境温度为-20℃~+40℃，需加油出厂时，请选此项）  
 B=合成润滑油VG460（环境温度为<0℃，需加油出厂时，推荐选用此项）

## 4.Type Designation

**Series**  
**Stages**  
 2-stage  
**Size**  
**Mounting Mode**  
 H=Horizontal foot-mounted  
 F=Flange-mounted  
 S=Short flange-mounted  
 A=Shaft-mounted  
 T=Torque arm-mounted with bottom accessory  
**Output Mode**  
 A/B/D/E=Unidirectional output shaft  
 C/F=Bidirectional output shaft  
 G/H=Hollow shaft with parallel key  
 I/J=Hollow shaft with shrink disk  
 K/L=Hollow shaft with involute spline  
**Nominal Ratio Code**  
**Mounting Positions**  
 D1/D2/D3/D4/D5/D6

S 2 05 H A - C40 - D1 0 1 -

**Accessories and Specific Configuration**  
 0=None  
 6=Oil compensating tank

**Oil Code**  
 0=Without oil filling(Please select this option when you do not need lubricating oil);  
 4=With mineral oil VG680(Please select this option when the ambient temperature is -20℃~+40℃);  
 B=With synthetic lubricating oil VG460(It is recommended to select this option when you need lubricating oil and the ambient temperature is below 0℃);

MH080M4A75 A L 2 - D 0 EC 0 - 0 1 1

进线孔位置

1/3/4

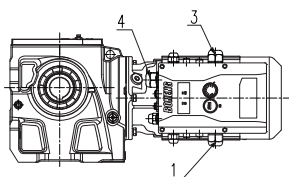

Cable entry location

1/3/4

接线盒位置

1/2/3/4

Terminal box location

1/2/3/4

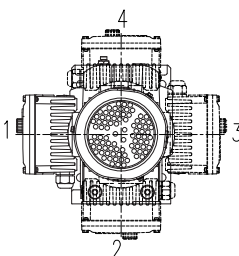

马达安装方位 0

Motor mounting position 0

一体机防护等级

0=IP55

1=IP55和防雨罩

Protection degree

0=IP55

1=IP55+Rain cover

通讯协议

MB=Modbus RTU

EC=EtherCAT

Communication protocol

MB=Modbus RTU

EC=EtherCAT

调速旋钮 1 )

0=无调速旋钮

1=有调速旋钮

Speed control knob 1 )

0=No speed control knob

1=Speed control knob

驱动器

D=分布式

Drive

D=Distributed

频率/电压代号

2=47~63Hz/380~480V

Code of voltage and frequency

2=47~63Hz/380~480V

机座材质

L=铝机座

Cast-aluminum frame

L=Aluminum

安装形式A

Construction type A

功率 (kW)	MH=IE2三相交流异步马达4极规格 MP=IE3三相交流异步马达4极规格	
Power (kW)	MH=IE2 4-pole three-phase asynchronous motor MP=IE3 4-pole three-phase asynchronous motor	
0.25	MH071M4A25... MP071M4A25...	1.1 MH090S4B11... MP090S4B11...
0.37	MH071M4A37... MP071M4A37...	1.5 MH090S4B15... MP090M4B15...
0.55	MH080M4A55... MP080M4A55...	2.2 MH100M4B22... MP100M4B22...
0.75	MH080M4A75... MP080M4A75...	3 MH100M4B30... MP100M4B30...

### 5.传动能力表

### 5.Transmission Capacity

马达 额定功率	马达 额定转速	减速机实际 输出转速	减速机实际 输出扭矩	减速机公称 减速比代号	减速机公称 减速比	减速机精确 减速比	减速机额定 输出扭矩	服务系数	通讯方式	订货号
Motor Rated Power	Motor Rated Speed	Actual Output Speed of Gearmotor	Actual Output Torque of Gearmotor	Nominal Ratio Code of Gearmotor	Nominal Ratio of Gearmotor	Exact Ratio of Gearmotor	Normal Output Torque of Gearmotor	Service Coefficient	Communication Mode	Order Code
$P_{IN}$ (kw)	$n_{IN}$ (r/min)	$n_{2N}$ (r/min)	$T_2$ (N.m)	Code	$i_N$	$i_{ex}$	$T_{2N}$ (N.m)	f		
0.25	1380	203	10	B71	7.1	6.81	55	5.5	MB/EC	S203□□-B71-D□□□-□□071□4A25AL□-D□□□□-0□□
0.25	1380	180	11	B80	8	7.68	55	5	MB/EC	S203□□-B80-D□□□-□□071□4A25AL□-D□□□□-0□□
0.25	1380	158	13	B90	9	8.75	55	4.23	MB/EC	S203□□-B90-D□□□-□□071□4A25AL□-D□□□□-0□□
0.25	1380	140	15	C10	10	9.89	60	4	MB/EC	S203□□-C10-D□□□-□□071□4A25AL□-D□□□□-0□□
0.25	1380	123	17	C11	11.2	11.2	60	3.53	MB/EC	S203□□-C11-D□□□-□□071□4A25AL□-D□□□□-0□□
0.25	1380	114	18	C13	12.5	12.1	60	3.33	MB/EC	S203□□-C13-D□□□-□□071□4A25AL□-D□□□□-0□□
0.25	1380	97.9	21	C14	14	14.1	65	3.1	MB/EC	S203□□-C14-D□□□-□□071□4A25AL□-D□□□□-0□□
0.25	1380	86.3	24	C16	16	16.0	70	2.92	MB/EC	S203□□-C16-D□□□-□□071□4A25AL□-D□□□□-0□□
0.25	1380	78.4	23	C18	18	17.6	65	2.83	MB/EC	S203□□-C18-D□□□-□□071□4A25AL□-D□□□□-0□□
0.25	1380	71.5	25	C20	20	19.3	70	2.8	MB/EC	S203□□-C20-D□□□-□□071□4A25AL□-D□□□□-0□□
0.25	1380	65.7	27	C22	22.4	21.0	75	2.78	MB/EC	S203□□-C22-D□□□-□□071□4A25AL□-D□□□□-0□□
0.25	1380	57.5	31	C25	25	24.0	75	2.42	MB/EC	S203□□-C25-D□□□-□□071□4A25AL□-D□□□□-0□□
0.25	1380	50.9	35	C28	28	27.1	80	2.29	MB/EC	S203□□-C28-D□□□-□□071□4A25AL□-D□□□□-0□□
0.25	1380	45	40	C32	31.5	30.7	80	2	MB/EC	S203□□-C32-D□□□-□□071□4A25AL□-D□□□□-0□□
0.25	1380	41.8	43	C36	35.5	33.0	80	1.86	MB/EC	S203□□-C36-D□□□-□□071□4A25AL□-D□□□□-0□□
0.25	1380	35.7	51	C40	40	38.7	80	1.57	MB/EC	S203□□-C40-D□□□-□□071□4A25AL□-D□□□□-0□□
0.25	1380	31.5	57	C45	45	43.8	85	1.49	MB/EC	S203□□-C45-D□□□-□□071□4A25AL□-D□□□□-0□□
0.25	1380	28.6	63	C50	50	48.3	85	1.35	MB/EC	S203□□-C50-D□□□-□□071□4A25AL□-D□□□□-0□□
0.25	1380	24.7	59	C56	56	55.9	80	1.36	MB/EC	S203□□-C56-D□□□-□□071□4A25AL□-D□□□□-0□□
0.25	1380	21.9	67	C63	63	63.1	85	1.27	MB/EC	S203□□-C63-D□□□-□□071□4A25AL□-D□□□□-0□□
0.25	1380	19.2	76	C71	71	71.9	85	1.12	MB/EC	S203□□-C71-D□□□-□□071□4A25AL□-D□□□□-0□□
0.25	1380	17	86	C80	80	81.3	85	0.99	MB/EC	S203□□-C80-D□□□-□□071□4A25AL□-D□□□□-0□□
0.25	1380	15	97	C90	90	92.0	90	0.93	MB/EC	S203□□-C90-D□□□-□□071□4A25AL□-D□□□□-0□□
0.25	1380	13.9	104	D10	100	99.1	95	0.91	MB/EC	S203□□-D10-D□□□-□□071□4A25AL□-D□□□□-0□□
0.25	1380	17.6	82	C80	80	78.2	170	2.07	MB/EC	S204□□-C80-D□□□-□□071□4A25AL□-D□□□□-0□□
0.25	1380	15.5	94	C90	90	89.1	170	1.81	MB/EC	S204□□-C90-D□□□-□□071□4A25AL□-D□□□□-0□□
0.25	1380	13.7	106	D10	100	100.7	170	1.6	MB/EC	S204□□-D10-D□□□-□□071□4A25AL□-D□□□□-0□□
0.25	1380	12.1	120	D11	112	114.0	170	1.42	MB/EC	S204□□-D11-D□□□-□□071□4A25AL□-D□□□□-0□□
0.25	1380	11.2	119	D13	125	122.8	170	1.43	MB/EC	S204□□-D13-D□□□-□□071□4A25AL□-D□□□□-0□□
0.25	1380	9.6	139	D14	140	143.7	170	1.22	MB/EC	S204□□-D14-D□□□-□□071□4A25AL□-D□□□□-0□□
0.25	1380	8.5	158	D16	160	162.9	170	1.08	MB/EC	S204□□-D16-D□□□-□□071□4A25AL□-D□□□□-0□□
0.25	1380	7.7	174	D18	180	179.6	170	0.98	MB/EC	S204□□-D18-D□□□-□□071□4A25AL□-D□□□□-0□□
0.25	1380	7	190	D20	200	196.3	170	0.89	MB/EC	S204□□-D20-D□□□-□□071□4A25AL□-D□□□□-0□□
0.25	1380	6.4	208	D22	224	214.6	170	0.82	MB/EC	S204□□-D22-D□□□-□□071□4A25AL□-D□□□□-0□□

马达 额定功率	马达 额定转速	减速机实际 输出转速	减速机实际 输出扭矩	减速机公称 减速比代号	减速机公称 减速比	减速机精确 减速比	减速机额定 输出扭矩	服务系数	通讯方式	订货号
Motor Rated Power	Motor Rated Speed	Actual Output Speed of Gearmotor	Actual Output Torque of Gearmotor	Nominal Ratio Code of Gearmotor	Nominal Ratio of Gearmotor	Exact Ratio of Gearmotor	Normal Output Torque of Gearmotor	Service Coefficient	Communication Mode	Order Code
$P_{IN}$ (kw)	$n_{IN}$ (r/min)	$n_{2N}$ (r/min)	$T_2$ (N.m)	Code	$i_N$	$i_{ex}$	$T_{2N}$ (N.m)	f		
0.37	1385	203	16	B71	7.1	6.81	55	3.44	MB/EC	S203□□-B71-D□□□-□□071□4A37AL□-D□□□□-0□□
0.37	1385	180	18	B80	8	7.68	55	3.06	MB/EC	S203□□-B80-D□□□-□□071□4A37AL□-D□□□□-0□□
0.37	1385	158	20	B90	9	8.75	55	2.75	MB/EC	S203□□-B90-D□□□-□□071□4A37AL□-D□□□□-0□□
0.37	1385	140	23	C10	10	9.89	60	2.61	MB/EC	S203□□-C10-D□□□-□□071□4A37AL□-D□□□□-0□□
0.37	1385	124	26	C11	11.2	11.2	60	2.31	MB/EC	S203□□-C11-D□□□-□□071□4A37AL□-D□□□□-0□□
0.37	1385	114	28	C13	12.5	12.1	60	2.14	MB/EC	S203□□-C13-D□□□-□□071□4A37AL□-D□□□□-0□□
0.37	1385	98.2	32	C14	14	14.1	65	2.03	MB/EC	S203□□-C14-D□□□-□□071□4A37AL□-D□□□□-0□□
0.37	1385	86.6	37	C16	16	16.0	70	1.89	MB/EC	S203□□-C16-D□□□-□□071□4A37AL□-D□□□□-0□□
0.37	1385	78.7	35	C18	18	17.6	65	1.86	MB/EC	S203□□-C18-D□□□-□□071□4A37AL□-D□□□□-0□□
0.37	1385	71.8	39	C20	20	19.3	70	1.79	MB/EC	S203□□-C20-D□□□-□□071□4A37AL□-D□□□□-0□□
0.37	1385	66	42	C22	22.4	21.0	75	1.79	MB/EC	S203□□-C22-D□□□-□□071□4A37AL□-D□□□□-0□□
0.37	1385	57.7	48	C25	25	24.0	75	1.56	MB/EC	S203□□-C25-D□□□-□□071□4A37AL□-D□□□□-0□□
0.37	1385	51.1	54	C28	28	27.1	80	1.48	MB/EC	S203□□-C28-D□□□-□□071□4A37AL□-D□□□□-0□□
0.37	1385	45.1	61	C32	31.5	30.7	80	1.31	MB/EC	S203□□-C32-D□□□-□□071□4A37AL□-D□□□□-0□□
0.37	1385	42	66	C36	35.5	33.0	80	1.21	MB/EC	S203□□-C36-D□□□-□□071□4A37AL□-D□□□□-0□□
0.37	1385	35.8	77	C40	40	38.7	80	1.04	MB/EC	S203□□-C40-D□□□-□□071□4A37AL□-D□□□□-0□□
0.37	1385	31.6	88	C45	45	43.8	85	0.97	MB/EC	S203□□-C45-D□□□-□□071□4A37AL□-D□□□□-0□□
0.37	1385	28.7	97	C50	50	48.3	85	0.88	MB/EC	S203□□-C50-D□□□-□□071□4A37AL□-D□□□□-0□□
0.37	1385	24.8	90	C56	56	55.9	80	0.89	MB/EC	S203□□-C56-D□□□-□□071□4A37AL□-D□□□□-0□□
0.37	1385	21.9	102	C63	63	63.1	85	0.83	MB/EC	S203□□-C63-D□□□-□□071□4A37AL□-D□□□□-0□□
0.37	1385	31.5	88	C45	45	43.9	165	1.88	MB/EC	S204□□-C45-D□□□-□□071□4A37AL□-D□□□□-0□□
0.37	1385	27.7	100	C50	50	50.0	180	1.8	MB/EC	S204□□-C50-D□□□-□□071□4A37AL□-D□□□□-0□□
0.37	1385	24.5	91	C56	56	56.5	155	1.7	MB/EC	S204□□-C56-D□□□-□□071□4A37AL□-D□□□□-0□□
0.37	1385	21.6	103	C63	63	64.0	160	1.55	MB/EC	S204□□-C63-D□□□-□□071□4A37AL□-D□□□□-0□□
0.37	1385	20.1	111	C71	71	68.9	160	1.44	MB/EC	S204□□-C71-D□□□-□□071□4A37AL□-D□□□□-0□□
0.37	1385	17.7	126	C80	80	78.2	170	1.35	MB/EC	S204□□-C80-D□□□-□□071□4A37AL□-D□□□□-0□□
0.37	1385	15.5	144	C90	90	89.1	170	1.18	MB/EC	S204□□-C90-D□□□-□□071□4A37AL□-D□□□□-0□□
0.37	1385	13.8	162	D10	100	100.7	170	1.05	MB/EC	S204□□-D10-D□□□-□□071□4A37AL□-D□□□□-0□□
0.37	1385	12.1	184	D11	112	114.0	170	0.92	MB/EC	S204□□-D11-D□□□-□□071□4A37AL□-D□□□□-0□□
0.37	1385	11.3	182	D13	125	122.8	170	0.93	MB/EC	S204□□-D13-D□□□-□□071□4A37AL□-D□□□□-0□□
0.37	1385	9.6	213	D14	140	143.7	170	0.8	MB/EC	S204□□-D14-D□□□-□□071□4A37AL□-D□□□□-0□□
0.37	1385	14	159	D10	100	98.9	310	1.95	MB/EC	S205□□-D10-D□□□-□□071□4A37AL□-D□□□□-0□□
0.37	1385	12.6	177	D11	112	109.8	300	1.69	MB/EC	S205□□-D11-D□□□-□□071□4A37AL□-D□□□□-0□□
0.37	1385	11	186	D13	125	125.8	300	1.61	MB/EC	S205□□-D13-D□□□-□□071□4A37AL□-D□□□□-0□□
0.37	1385	10	205	D14	140	138.3	300	1.46	MB/EC	S205□□-D14-D□□□-□□071□4A37AL□-D□□□□-0□□
0.37	1385	8.9	231	D16	160	155.9	300	1.3	MB/EC	S205□□-D16-D□□□-□□071□4A37AL□-D□□□□-0□□
0.37	1385	8.3	247	D18	180	166.6	300	1.21	MB/EC	S205□□-D18-D□□□-□□071□4A37AL□-D□□□□-0□□
0.37	1385	7.2	287	D20	200	193.6	300	1.05	MB/EC	S205□□-D20-D□□□-□□071□4A37AL□-D□□□□-0□□
0.37	1385	6.4	323	D22	224	217.9	300	0.93	MB/EC	S205□□-D22-D□□□-□□071□4A37AL□-D□□□□-0□□

马达 额定功率	马达 额定转速	减速机实际 输出转速	减速机实际 输出扭矩	减速机公称 减速比代号	减速机公称 减速比	减速机精确 减速比	减速机额定 输出扭矩	服务系数	通讯方式	订货号
Motor Rated Power	Motor Rated Speed	Actual Output Speed of Gearmotor	Actual Output Torque of Gearmotor	Nominal Ratio Code of Gearmotor	Nominal Ratio of Gearmotor	Exact Ratio of Gearmotor	Normal Output Torque of Gearmotor	Service Coefficient	Communication Mode	Order Code
P <sub>1N</sub> (kw)	n <sub>1N</sub> (r/min)	n <sub>2N</sub> (r/min)	T <sub>2</sub> (N.m)	Code	i <sub>N</sub>	i <sub>ex</sub>	T <sub>2N</sub> (N.m)	f		
0.55	1430	210	22	B71	7.1	6.81	55	2.5	MB/EC	S203□□-B71-D□□□-□□080□4A55AL□-D□□□□-0□□
0.55	1430	186	25	B80	8	7.68	55	2.2	MB/EC	S203□□-B80-D□□□-□□080□4A55AL□-D□□□□-0□□
0.55	1430	163	28	B90	9	8.75	55	1.96	MB/EC	S203□□-B90-D□□□-□□080□4A55AL□-D□□□□-0□□
0.55	1430	145	32	C10	10	9.89	60	1.88	MB/EC	S203□□-C10-D□□□-□□080□4A55AL□-D□□□□-0□□
0.55	1430	128	36	C11	11.2	11.2	60	1.67	MB/EC	S203□□-C11-D□□□-□□080□4A55AL□-D□□□□-0□□
0.55	1430	118	39	C13	12.5	12.1	60	1.54	MB/EC	S203□□-C13-D□□□-□□080□4A55AL□-D□□□□-0□□
0.55	1430	101	46	C14	14	14.1	65	1.41	MB/EC	S203□□-C14-D□□□-□□080□4A55AL□-D□□□□-0□□
0.55	1430	89.4	52	C16	16	16.0	70	1.35	MB/EC	S203□□-C16-D□□□-□□080□4A55AL□-D□□□□-0□□
0.55	1430	81.3	50	C18	18	17.6	65	1.3	MB/EC	S203□□-C18-D□□□-□□080□4A55AL□-D□□□□-0□□
0.55	1430	74.1	55	C20	20	19.3	70	1.27	MB/EC	S203□□-C20-D□□□-□□080□4A55AL□-D□□□□-0□□
0.55	1430	68.1	60	C22	22.4	21.0	75	1.25	MB/EC	S203□□-C22-D□□□-□□080□4A55AL□-D□□□□-0□□
0.55	1430	59.6	68	C25	25	24.0	75	1.1	MB/EC	S203□□-C25-D□□□-□□080□4A55AL□-D□□□□-0□□
0.55	1430	52.8	77	C28	28	27.1	80	1.04	MB/EC	S203□□-C28-D□□□-□□080□4A55AL□-D□□□□-0□□
0.55	1430	46.6	87	C32	31.5	30.7	80	0.92	MB/EC	S203□□-C32-D□□□-□□080□4A55AL□-D□□□□-0□□
0.55	1430	43.3	94	C36	35.5	33.0	80	0.85	MB/EC	S203□□-C36-D□□□-□□080□4A55AL□-D□□□□-0□□
0.55	1430	49.8	82	C28	28	28.7	160	1.95	MB/EC	S204□□-C28-D□□□-□□080□4A55AL□-D□□□□-0□□
0.55	1430	46.3	88	C32	31.5	30.9	160	1.82	MB/EC	S204□□-C32-D□□□-□□080□4A55AL□-D□□□□-0□□
0.55	1430	40.5	101	C36	35.5	35.3	160	1.58	MB/EC	S204□□-C36-D□□□-□□080□4A55AL□-D□□□□-0□□
0.55	1430	36.8	111	C40	40	38.9	160	1.44	MB/EC	S204□□-C40-D□□□-□□080□4A55AL□-D□□□□-0□□
0.55	1430	32.6	125	C45	45	43.9	165	1.32	MB/EC	S204□□-C45-D□□□-□□080□4A55AL□-D□□□□-0□□
0.55	1430	28.6	142	C50	50	50.0	180	1.27	MB/EC	S204□□-C50-D□□□-□□080□4A55AL□-D□□□□-0□□
0.55	1430	25.3	130	C56	56	56.5	155	1.19	MB/EC	S204□□-C56-D□□□-□□080□4A55AL□-D□□□□-0□□
0.55	1430	22.3	147	C63	63	64.0	160	1.09	MB/EC	S204□□-C63-D□□□-□□080□4A55AL□-D□□□□-0□□
0.55	1430	20.8	158	C71	71	68.9	160	1.01	MB/EC	S204□□-C71-D□□□-□□080□4A55AL□-D□□□□-0□□
0.55	1430	18.3	179	C80	80	78.2	170	0.95	MB/EC	S204□□-C80-D□□□-□□080□4A55AL□-D□□□□-0□□
0.55	1430	16	204	C90	90	89.1	170	0.83	MB/EC	S204□□-C90-D□□□-□□080□4A55AL□-D□□□□-0□□
0.55	1430	20.3	161	C71	71	70.3	300	1.86	MB/EC	S205□□-C71-D□□□-□□080□4A55AL□-D□□□□-0□□
0.55	1430	18.1	182	C80	80	79.2	300	1.65	MB/EC	S205□□-C80-D□□□-□□080□4A55AL□-D□□□□-0□□
0.55	1430	16.3	201	C90	90	87.6	300	1.49	MB/EC	S205□□-C90-D□□□-□□080□4A55AL□-D□□□□-0□□
0.55	1430	14.5	227	D10	100	98.9	310	1.37	MB/EC	S205□□-D10-D□□□-□□080□4A55AL□-D□□□□-0□□
0.55	1430	13	252	D11	112	109.8	300	1.19	MB/EC	S205□□-D11-D□□□-□□080□4A55AL□-D□□□□-0□□
0.55	1430	11.4	265	D13	125	125.8	300	1.13	MB/EC	S205□□-D13-D□□□-□□080□4A55AL□-D□□□□-0□□
0.55	1430	10.3	292	D14	140	138.3	300	1.03	MB/EC	S205□□-D14-D□□□-□□080□4A55AL□-D□□□□-0□□
0.55	1430	9.2	329	D16	160	155.9	300	0.91	MB/EC	S205□□-D16-D□□□-□□080□4A55AL□-D□□□□-0□□
0.55	1430	8.6	351	D18	180	166.6	300	0.85	MB/EC	S205□□-D18-D□□□-□□080□4A55AL□-D□□□□-0□□
0.55	1430	9.7	310	D14	140	146.8	520	1.68	MB/EC	S206□□-D14-D□□□-□□080□4A55AL□-D□□□□-0□□
0.55	1430	8.9	338	D16	160	160.5	520	1.54	MB/EC	S206□□-D16-D□□□-□□080□4A55AL□-D□□□□-0□□
0.55	1430	7.8	385	D18	180	182.6	520	1.35	MB/EC	S206□□-D18-D□□□-□□080□4A55AL□-D□□□□-0□□
0.55	1430	7.4	409	D20	200	194.1	520	1.27	MB/EC	S206□□-D20-D□□□-□□080□4A55AL□-D□□□□-0□□
0.55	1430	6.4	473	D22	224	224.4	520	1.1	MB/EC	S206□□-D22-D□□□-□□080□4A55AL□-D□□□□-0□□
0.55	1430	5.4	563	D25	250	266.8	520	0.92	MB/EC	S206□□-D25-D□□□-□□080□4A55AL□-D□□□□-0□□
0.55	1430	5	599	D28	280	283.9	520	0.87	MB/EC	S206□□-D28-D□□□-□□080□4A55AL□-D□□□□-0□□

马达额定功率	马达额定转速	减速机实际输出转速	减速机实际输出扭矩	减速机公称减速比代号	减速机公称减速比	减速机精确减速比	减速机额定输出扭矩	服务系数	通讯方式	订货号
Motor Rated Power	Motor Rated Speed	Actual Output Speed of Gearmotor	Actual Output Torque of Gearmotor	Nominal Ratio Code of Gearmotor	Nominal Ratio of Gearmotor	Exact Ratio of Gearmotor	Normal Output Torque of Gearmotor	Service Coefficient	Communication Mode	Order Code
P <sub>IN</sub> (kw)	n <sub>IN</sub> (r/min)	n <sub>2N</sub> (r/min)	T <sub>2</sub> (N.m)	Code	i <sub>N</sub>	i <sub>ex</sub>	T <sub>2N</sub> (N.m)	f		
0.75	1430	210	30	B71	7.1	6.81	55	1.83	MB/EC	S203□□-B71-D□□□-□□080□4A75AL□-D□□□□-0□□□
0.75	1430	186	34	B80	8	7.68	55	1.62	MB/EC	S203□□-B80-D□□□-□□080□4A75AL□-D□□□□-0□□□
0.75	1430	163	39	B90	9	8.75	55	1.41	MB/EC	S203□□-B90-D□□□-□□080□4A75AL□-D□□□□-0□□□
0.75	1430	145	44	C10	10	9.89	60	1.36	MB/EC	S203□□-C10-D□□□-□□080□4A75AL□-D□□□□-0□□□
0.75	1430	128	49	C11	11.2	11.2	60	1.22	MB/EC	S203□□-C11-D□□□-□□080□4A75AL□-D□□□□-0□□□
0.75	1430	118	53	C13	12.5	12.1	60	1.13	MB/EC	S203□□-C13-D□□□-□□080□4A75AL□-D□□□□-0□□□
0.75	1430	101	62	C14	14	14.1	65	1.05	MB/EC	S203□□-C14-D□□□-□□080□4A75AL□-D□□□□-0□□□
0.75	1430	89.4	70	C16	16	16.0	70	1	MB/EC	S203□□-C16-D□□□-□□080□4A75AL□-D□□□□-0□□□
0.75	1430	81.3	68	C18	18	17.6	65	0.96	MB/EC	S203□□-C18-D□□□-□□080□4A75AL□-D□□□□-0□□□
0.75	1430	74.1	74	C20	20	19.3	70	0.95	MB/EC	S203□□-C20-D□□□-□□080□4A75AL□-D□□□□-0□□□
0.75	1430	68.1	81	C22	22.4	21.0	75	0.93	MB/EC	S203□□-C22-D□□□-□□080□4A75AL□-D□□□□-0□□□
0.75	1430	59.6	92	C25	25	24.0	75	0.82	MB/EC	S203□□-C25-D□□□-□□080□4A75AL□-D□□□□-0□□□
0.75	1430	90.5	70	C16	16	15.8	120	1.71	MB/EC	S204□□-C16-D□□□-□□080□4A75AL□-D□□□□-0□□□
0.75	1430	82.2	67	C18	18	17.4	120	1.79	MB/EC	S204□□-C18-D□□□-□□080□4A75AL□-D□□□□-0□□□
0.75	1430	72.6	76	C20	20	19.7	135	1.78	MB/EC	S204□□-C20-D□□□-□□080□4A75AL□-D□□□□-0□□□
0.75	1430	63.8	86	C22	22.4	22.4	150	1.74	MB/EC	S204□□-C22-D□□□-□□080□4A75AL□-D□□□□-0□□□
0.75	1430	56.5	97	C25	25	25.3	160	1.65	MB/EC	S204□□-C25-D□□□-□□080□4A75AL□-D□□□□-0□□□
0.75	1430	49.8	110	C28	28	28.7	160	1.45	MB/EC	S204□□-C28-D□□□-□□080□4A75AL□-D□□□□-0□□□
0.75	1430	46.3	119	C32	31.5	30.9	160	1.34	MB/EC	S204□□-C32-D□□□-□□080□4A75AL□-D□□□□-0□□□
0.75	1430	40.5	136	C36	35.5	35.3	160	1.18	MB/EC	S204□□-C36-D□□□-□□080□4A75AL□-D□□□□-0□□□
0.75	1430	36.8	150	C40	40	38.9	160	1.07	MB/EC	S204□□-C40-D□□□-□□080□4A75AL□-D□□□□-0□□□
0.75	1430	32.6	169	C45	45	43.9	165	0.98	MB/EC	S204□□-C45-D□□□-□□080□4A75AL□-D□□□□-0□□□
0.75	1430	28.6	193	C50	50	50.0	180	0.93	MB/EC	S204□□-C50-D□□□-□□080□4A75AL□-D□□□□-0□□□
0.75	1430	25.3	175	C56	56	56.5	155	0.89	MB/EC	S204□□-C56-D□□□-□□080□4A75AL□-D□□□□-0□□□
0.75	1430	22.3	198	C63	63	64.0	160	0.81	MB/EC	S204□□-C63-D□□□-□□080□4A75AL□-D□□□□-0□□□
0.75	1430	35.7	154	C40	40	40.1	260	1.69	MB/EC	S205□□-C40-D□□□-□□080□4A75AL□-D□□□□-0□□□
0.75	1430	32.1	171	C45	45	44.5	260	1.52	MB/EC	S205□□-C45-D□□□-□□080□4A75AL□-D□□□□-0□□□
0.75	1430	28.4	194	C50	50	50.3	290	1.49	MB/EC	S205□□-C50-D□□□-□□080□4A75AL□-D□□□□-0□□□
0.75	1430	25.6	173	C56	56	55.8	245	1.42	MB/EC	S205□□-C56-D□□□-□□080□4A75AL□-D□□□□-0□□□
0.75	1430	22.4	198	C63	63	63.9	270	1.36	MB/EC	S205□□-C63-D□□□-□□080□4A75AL□-D□□□□-0□□□
0.75	1430	20.3	218	C71	71	70.3	300	1.38	MB/EC	S205□□-C71-D□□□-□□080□4A75AL□-D□□□□-0□□□
0.75	1430	18.1	246	C80	80	79.2	300	1.22	MB/EC	S205□□-C80-D□□□-□□080□4A75AL□-D□□□□-0□□□
0.75	1430	16.3	272	C90	90	87.6	300	1.1	MB/EC	S205□□-C90-D□□□-□□080□4A75AL□-D□□□□-0□□□
0.75	1430	14.5	307	D10	100	98.9	310	1.01	MB/EC	S205□□-D10-D□□□-□□080□4A75AL□-D□□□□-0□□□
0.75	1430	13	340	D11	112	109.8	300	0.88	MB/EC	S205□□-D11-D□□□-□□080□4A75AL□-D□□□□-0□□□
0.75	1430	11.4	359	D13	125	125.8	300	0.84	MB/EC	S205□□-D13-D□□□-□□080□4A75AL□-D□□□□-0□□□
0.75	1430	14.9	297	D10	100	95.8	520	1.75	MB/EC	S206□□-D10-D□□□-□□080□4A75AL□-D□□□□-0□□□
0.75	1430	12.2	365	D11	112	117.6	520	1.42	MB/EC	S206□□-D11-D□□□-□□080□4A75AL□-D□□□□-0□□□
0.75	1430	11.1	369	D13	125	129.3	520	1.41	MB/EC	S206□□-D13-D□□□-□□080□4A75AL□-D□□□□-0□□□
0.75	1430	9.7	418	D14	140	146.8	520	1.24	MB/EC	S206□□-D14-D□□□-□□080□4A75AL□-D□□□□-0□□□
0.75	1430	8.9	457	D16	160	160.5	520	1.14	MB/EC	S206□□-D16-D□□□-□□080□4A75AL□-D□□□□-0□□□
0.75	1430	7.8	520	D18	180	182.6	520	1	MB/EC	S206□□-D18-D□□□-□□080□4A75AL□-D□□□□-0□□□
0.75	1430	7.4	553	D20	200	194.1	520	0.94	MB/EC	S206□□-D20-D□□□-□□080□4A75AL□-D□□□□-0□□□
0.75	1430	6.4	640	D22	224	224.4	520	0.81	MB/EC	S206□□-D22-D□□□-□□080□4A75AL□-D□□□□-0□□□
0.75	1430	8.1	501	D18	180	175.9	1300	2.59	MB/EC	S207□□-D18-D□□□-□□080□4A75AL□-D□□□□-0□□□
0.75	1430	7.2	563	D20	200	197.7	1300	2.31	MB/EC	S207□□-D20-D□□□-□□080□4A75AL□-D□□□□-0□□□
0.75	1430	6.6	617	D22	224	216.6	1300	2.11	MB/EC	S207□□-D22-D□□□-□□080□4A75AL□-D□□□□-0□□□
0.75	1430	5.6	725	D25	250	254.3	1300	1.79	MB/EC	S207□□-D25-D□□□-□□080□4A75AL□-D□□□□-0□□□
0.75	1430	5.1	805	D28	280	282.6	1300	1.61	MB/EC	S207□□-D28-D□□□-□□080□4A75AL□-D□□□□-0□□□
0.75	1430	4.6	886	D32	315	310.9	1300	1.47	MB/EC	S207□□-D32-D□□□-□□080□4A75AL□-D□□□□-0□□□
0.75	1430	4.1	999	D36	355	350.6	1300	1.3	MB/EC	S207□□-D36-D□□□-□□080□4A75AL□-D□□□□-0□□□

马达 额定功率	马达 额定转速	减速机实际 输出转速	减速机实际 输出扭矩	减速机公称 减速比代号	减速机公称 减速比	减速机精确 减速比	减速机额定 输出扭矩	服务系数	通讯方式	订货号
Motor Rated Power	Motor Rated Speed	Actual Output Speed of Gearmotor	Actual Output Torque of Gearmotor	Nominal Ratio Code of Gearmotor	Nominal Ratio of Gearmotor	Exact Ratio of Gearmotor	Normal Output Torque of Gearmotor	Service Coefficient	Communication Mode	Order Code
P <sub>1N</sub> (kw)	n <sub>1N</sub> (r/min)	n <sub>2N</sub> (r/min)	T <sub>2</sub> (N.m)	Code	i <sub>N</sub>	i <sub>ex</sub>	T <sub>2N</sub> (N.m)	f		
1.1	1435	197	47	B71	7.1	7.28	110	2.34	MB/EC	S204□□-B71-D□□□-□□090□4B11AL□-D□□□□-0□□
1.1	1435	179	52	B80	8	8.03	110	2.12	MB/EC	S204□□-B80-D□□□-□□090□4B11AL□-D□□□□-0□□
1.1	1435	159	58	B90	9	9.05	110	1.9	MB/EC	S204□□-B90-D□□□-□□090□4B11AL□-D□□□□-0□□
1.1	1435	139	66	C10	10	10.3	110	1.67	MB/EC	S204□□-C10-D□□□-□□090□4B11AL□-D□□□□-0□□
1.1	1435	123	75	C11	11.2	11.7	110	1.47	MB/EC	S204□□-C11-D□□□-□□090□4B11AL□-D□□□□-0□□
1.1	1435	109	85	C13	12.5	13.2	110	1.29	MB/EC	S204□□-C13-D□□□-□□090□4B11AL□-D□□□□-0□□
1.1	1435	101	91	C14	14	14.2	120	1.32	MB/EC	S204□□-C14-D□□□-□□090□4B11AL□-D□□□□-0□□
1.1	1435	90.8	101	C16	16	15.8	120	1.19	MB/EC	S204□□-C16-D□□□-□□090□4B11AL□-D□□□□-0□□
1.1	1435	82.5	98	C18	18	17.4	120	1.22	MB/EC	S204□□-C18-D□□□-□□090□4B11AL□-D□□□□-0□□
1.1	1435	72.8	111	C20	20	19.7	135	1.22	MB/EC	S204□□-C20-D□□□-□□090□4B11AL□-D□□□□-0□□
1.1	1435	64.1	126	C22	22.4	22.4	150	1.19	MB/EC	S204□□-C22-D□□□-□□090□4B11AL□-D□□□□-0□□
1.1	1435	56.7	142	C25	25	25.3	160	1.13	MB/EC	S204□□-C25-D□□□-□□090□4B11AL□-D□□□□-0□□
1.1	1435	50	161	C28	28	28.7	160	0.99	MB/EC	S204□□-C28-D□□□-□□090□4B11AL□-D□□□□-0□□
1.1	1435	46.4	174	C32	31.5	30.9	160	0.92	MB/EC	S204□□-C32-D□□□-□□090□4B11AL□-D□□□□-0□□
1.1	1435	40.7	198	C36	35.5	35.3	160	0.81	MB/EC	S204□□-C36-D□□□-□□090□4B11AL□-D□□□□-0□□
1.1	1435	54.4	148	C25	25	26.4	250	1.69	MB/EC	S205□□-C25-D□□□-□□090□4B11AL□-D□□□□-0□□
1.1	1435	47.4	170	C28	28	30.3	250	1.47	MB/EC	S205□□-C28-D□□□-□□090□4B11AL□-D□□□□-0□□
1.1	1435	43.2	187	C32	31.5	33.2	250	1.34	MB/EC	S205□□-C32-D□□□-□□090□4B11AL□-D□□□□-0□□
1.1	1435	38.3	211	C36	35.5	37.5	260	1.23	MB/EC	S205□□-C36-D□□□-□□090□4B11AL□-D□□□□-0□□
1.1	1435	35.8	225	C40	40	40.1	260	1.16	MB/EC	S205□□-C40-D□□□-□□090□4B11AL□-D□□□□-0□□
1.1	1435	32.2	250	C45	45	44.5	260	1.04	MB/EC	S205□□-C45-D□□□-□□090□4B11AL□-D□□□□-0□□
1.1	1435	28.5	283	C50	50	50.3	290	1.02	MB/EC	S205□□-C50-D□□□-□□090□4B11AL□-D□□□□-0□□
1.1	1435	25.7	253	C56	56	55.8	245	0.97	MB/EC	S205□□-C56-D□□□-□□090□4B11AL□-D□□□□-0□□
1.1	1435	22.5	289	C63	63	63.9	270	0.93	MB/EC	S205□□-C63-D□□□-□□090□4B11AL□-D□□□□-0□□
1.1	1435	20.4	318	C71	71	70.3	300	0.94	MB/EC	S205□□-C71-D□□□-□□090□4B11AL□-D□□□□-0□□
1.1	1435	18.1	358	C80	80	79.2	300	0.84	MB/EC	S205□□-C80-D□□□-□□090□4B11AL□-D□□□□-0□□
1.1	1435	29.9	270	C50	50	48.0	540	2	MB/EC	S206□□-C50-D□□□-□□090□4B11AL□-D□□□□-0□□
1.1	1435	26.7	243	C56	56	53.8	480	1.98	MB/EC	S206□□-C56-D□□□-□□090□4B11AL□-D□□□□-0□□
1.1	1435	23.3	279	C63	63	61.6	500	1.79	MB/EC	S206□□-C63-D□□□-□□090□4B11AL□-D□□□□-0□□
1.1	1435	20.5	317	C71	71	70.0	500	1.58	MB/EC	S206□□-C71-D□□□-□□090□4B11AL□-D□□□□-0□□
1.1	1435	18.3	354	C80	80	78.3	500	1.41	MB/EC	S206□□-C80-D□□□-□□090□4B11AL□-D□□□□-0□□
1.1	1435	16.5	395	C90	90	87.2	520	1.32	MB/EC	S206□□-C90-D□□□-□□090□4B11AL□-D□□□□-0□□
1.1	1435	15	434	D10	100	95.8	520	1.2	MB/EC	S206□□-D10-D□□□-□□090□4B11AL□-D□□□□-0□□
1.1	1435	12.2	532	D11	112	117.6	520	0.98	MB/EC	S206□□-D11-D□□□-□□090□4B11AL□-D□□□□-0□□
1.1	1435	11.1	538	D13	125	129.3	520	0.97	MB/EC	S206□□-D13-D□□□-□□090□4B11AL□-D□□□□-0□□
1.1	1435	9.8	611	D14	140	146.8	520	0.85	MB/EC	S206□□-D14-D□□□-□□090□4B11AL□-D□□□□-0□□
1.1	1435	12.1	537	D11	112	118.6	1200	2.23	MB/EC	S207□□-D11-D□□□-□□090□4B11AL□-D□□□□-0□□
1.1	1435	10.8	552	D13	125	132.6	1200	2.17	MB/EC	S207□□-D13-D□□□-□□090□4B11AL□-D□□□□-0□□
1.1	1435	9.7	614	D14	140	147.6	1300	2.12	MB/EC	S207□□-D14-D□□□-□□090□4B11AL□-D□□□□-0□□
1.1	1435	8.9	673	D16	160	161.8	1300	1.93	MB/EC	S207□□-D16-D□□□-□□090□4B11AL□-D□□□□-0□□
1.1	1435	8.2	732	D18	180	175.9	1300	1.78	MB/EC	S207□□-D18-D□□□-□□090□4B11AL□-D□□□□-0□□
1.1	1435	7.3	823	D20	200	197.7	1300	1.58	MB/EC	S207□□-D20-D□□□-□□090□4B11AL□-D□□□□-0□□
1.1	1435	6.6	901	D22	224	216.6	1300	1.44	MB/EC	S207□□-D22-D□□□-□□090□4B11AL□-D□□□□-0□□
1.1	1435	5.6	1058	D25	250	254.3	1300	1.23	MB/EC	S207□□-D25-D□□□-□□090□4B11AL□-D□□□□-0□□

马达 额定功率	马达 额定转速	减速机实际 输出转速	减速机实际 输出扭矩	减速机公称 减速比代号	减速机公称 减速比	减速机精确 减速比	减速机额定 输出扭矩	服务系数	通讯方式	订货号
Motor Rated Power	Motor Rated Speed	Actual Output Speed of Gearmotor	Actual Output Torque of Gearmotor	Nominal Ratio Code of Gearmotor	Nominal Ratio of Gearmotor	Exact Ratio of Gearmotor	Normal Output Torque of Gearmotor	Service Coefficient	Communication Mode	Order Code
P <sub>IN</sub> (kw)	n <sub>IN</sub> (r/min)	n <sub>2N</sub> (r/min)	T <sub>2</sub> (N.m)	Code	i <sub>N</sub>	i <sub>ex</sub>	T <sub>2N</sub> (N.m)	f		
1.5	1435	197	64	B71	7.1	7.28	110	1.72	MB/EC	S204□□-B71-D□□□-□□090□4B15AL□-D□□□□-0□□
1.5	1435	179	71	B80	8	8.03	110	1.55	MB/EC	S204□□-B80-D□□□-□□090□4B15AL□-D□□□□-0□□
1.5	1435	159	80	B90	9	9.05	110	1.38	MB/EC	S204□□-B90-D□□□-□□090□4B15AL□-D□□□□-0□□
1.5	1435	139	91	C10	10	10.3	110	1.21	MB/EC	S204□□-C10-D□□□-□□090□4B15AL□-D□□□□-0□□
1.5	1435	123	103	C11	11.2	11.7	110	1.07	MB/EC	S204□□-C11-D□□□-□□090□4B15AL□-D□□□□-0□□
1.5	1435	109	116	C13	12.5	13.2	110	0.95	MB/EC	S204□□-C13-D□□□-□□090□4B15AL□-D□□□□-0□□
1.5	1435	101	125	C14	14	14.2	120	0.96	MB/EC	S204□□-C14-D□□□-□□090□4B15AL□-D□□□□-0□□
1.5	1435	90.8	139	C16	16	15.8	120	0.86	MB/EC	S204□□-C16-D□□□-□□090□4B15AL□-D□□□□-0□□
1.5	1435	82.5	134	C18	18	17.4	120	0.9	MB/EC	S204□□-C18-D□□□-□□090□4B15AL□-D□□□□-0□□
1.5	1435	72.8	152	C20	20	19.7	135	0.89	MB/EC	S204□□-C20-D□□□-□□090□4B15AL□-D□□□□-0□□
1.5	1435	64.1	172	C22	22.4	22.4	150	0.87	MB/EC	S204□□-C22-D□□□-□□090□4B15AL□-D□□□□-0□□
1.5	1435	56.7	195	C25	25	25.3	160	0.82	MB/EC	S204□□-C25-D□□□-□□090□4B15AL□-D□□□□-0□□
1.5	1435	112	113	C13	12.5	12.8	220	1.95	MB/EC	S205□□-C13-D□□□-□□090□4B15AL□-D□□□□-0□□
1.5	1435	102	124	C14	14	14.1	220	1.77	MB/EC	S205□□-C14-D□□□-□□090□4B15AL□-D□□□□-0□□
1.5	1435	90.8	139	C16	16	15.8	220	1.58	MB/EC	S205□□-C16-D□□□-□□090□4B15AL□-D□□□□-0□□
1.5	1435	76.3	145	C18	18	18.8	220	1.52	MB/EC	S205□□-C18-D□□□-□□090□4B15AL□-D□□□□-0□□
1.5	1435	68	162	C20	20	21.1	220	1.36	MB/EC	S205□□-C20-D□□□-□□090□4B15AL□-D□□□□-0□□
1.5	1435	60.3	183	C22	22.4	23.8	230	1.26	MB/EC	S205□□-C22-D□□□-□□090□4B15AL□-D□□□□-0□□
1.5	1435	54.4	203	C25	25	26.4	250	1.23	MB/EC	S205□□-C25-D□□□-□□090□4B15AL□-D□□□□-0□□
1.5	1435	47.4	233	C28	28	30.3	250	1.07	MB/EC	S205□□-C28-D□□□-□□090□4B15AL□-D□□□□-0□□
1.5	1435	43.2	256	C32	31.5	33.2	250	0.98	MB/EC	S205□□-C32-D□□□-□□090□4B15AL□-D□□□□-0□□
1.5	1435	38.3	289	C36	35.5	37.5	260	0.9	MB/EC	S205□□-C36-D□□□-□□090□4B15AL□-D□□□□-0□□
1.5	1435	35.8	309	C40	40	40.1	260	0.84	MB/EC	S205□□-C40-D□□□-□□090□4B15AL□-D□□□□-0□□
1.5	1435	45	246	C32	31.5	31.9	480	1.95	MB/EC	S206□□-C32-D□□□-□□090□4B15AL□-D□□□□-0□□
1.5	1435	39.5	280	C36	35.5	36.3	480	1.71	MB/EC	S206□□-C36-D□□□-□□090□4B15AL□-D□□□□-0□□
1.5	1435	36.1	306	C40	40	39.7	480	1.57	MB/EC	S206□□-C40-D□□□-□□090□4B15AL□-D□□□□-0□□
1.5	1435	31.8	347	C45	45	45.1	510	1.47	MB/EC	S206□□-C45-D□□□-□□090□4B15AL□-D□□□□-0□□
1.5	1435	29.9	370	C50	50	48.0	540	1.46	MB/EC	S206□□-C50-D□□□-□□090□4B15AL□-D□□□□-0□□
1.5	1435	26.7	334	C56	56	53.8	480	1.44	MB/EC	S206□□-C56-D□□□-□□090□4B15AL□-D□□□□-0□□
1.5	1435	23.3	382	C63	63	61.6	500	1.31	MB/EC	S206□□-C63-D□□□-□□090□4B15AL□-D□□□□-0□□
1.5	1435	20.5	434	C71	71	70.0	500	1.15	MB/EC	S206□□-C71-D□□□-□□090□4B15AL□-D□□□□-0□□
1.5	1435	18.3	485	C80	80	78.3	500	1.03	MB/EC	S206□□-C80-D□□□-□□090□4B15AL□-D□□□□-0□□
1.5	1435	16.5	541	C90	90	87.2	520	0.96	MB/EC	S206□□-C90-D□□□-□□090□4B15AL□-D□□□□-0□□
1.5	1435	15	594	D10	100	95.8	520	0.88	MB/EC	S206□□-D10-D□□□-□□090□4B15AL□-D□□□□-0□□
1.5	1435	15.6	570	C90	90	91.9	1100	1.93	MB/EC	S207□□-C90-D□□□-□□090□4B15AL□-D□□□□-0□□
1.5	1435	13.6	654	D10	100	105.5	1200	1.83	MB/EC	S207□□-D10-D□□□-□□090□4B15AL□-D□□□□-0□□
1.5	1435	12.1	735	D11	112	118.6	1200	1.63	MB/EC	S207□□-D11-D□□□-□□090□4B15AL□-D□□□□-0□□
1.5	1435	10.8	756	D13	125	132.6	1200	1.59	MB/EC	S207□□-D13-D□□□-□□090□4B15AL□-D□□□□-0□□
1.5	1435	9.7	841	D14	140	147.6	1300	1.55	MB/EC	S207□□-D14-D□□□-□□090□4B15AL□-D□□□□-0□□
1.5	1435	8.9	922	D16	160	161.8	1300	1.41	MB/EC	S207□□-D16-D□□□-□□090□4B15AL□-D□□□□-0□□
1.5	1435	8.2	1003	D18	180	175.9	1300	1.3	MB/EC	S207□□-D18-D□□□-□□090□4B15AL□-D□□□□-0□□
1.5	1435	7.3	1127	D20	200	197.7	1300	1.15	MB/EC	S207□□-D20-D□□□-□□090□4B15AL□-D□□□□-0□□
1.5	1435	6.6	1235	D22	224	216.6	1300	1.05	MB/EC	S207□□-D22-D□□□-□□090□4B15AL□-D□□□□-0□□
1.5	1435	5.6	1450	D25	250	254.3	1300	0.9	MB/EC	S207□□-D25-D□□□-□□090□4B15AL□-D□□□□-0□□
1.5	1435	6.3	1300	D22	224	228.0	2300	1.77	MB/EC	S208□□-D22-D□□□-□□090□4B15AL□-D□□□□-0□□
1.5	1435	5.6	1462	D25	250	256.5	2300	1.57	MB/EC	S208□□-D25-D□□□-□□090□4B15AL□-D□□□□-0□□
1.5	1435	5.1	1609	D28	280	282.2	2300	1.43	MB/EC	S208□□-D28-D□□□-□□090□4B15AL□-D□□□□-0□□
1.5	1435	4.7	1757	D32	315	308.3	2300	1.31	MB/EC	S208□□-D32-D□□□-□□090□4B15AL□-D□□□□-0□□



马达 额定功率	马达 额定转速	减速机实际 输出转速	减速机实际 输出扭矩	减速机公称 减速比代号	减速机公称 减速比	减速机精确 减速比	减速机额定 输出扭矩	服务系数	通讯方式	订货号
Motor Rated Power	Motor Rated Speed	Actual Output Speed of Gearmotor	Actual Output Torque of Gearmotor	Nominal Ratio Code of Gearmotor	Nominal Ratio of Gearmotor	Exact Ratio of Gearmotor	Normal Output Torque of Gearmotor	Service Coefficient	Communication Mode	Order Code
P <sub>IN</sub> (kw)	n <sub>1N</sub> (r/min)	n <sub>2N</sub> (r/min)	T <sub>2</sub> (N.m)	Code	i <sub>N</sub>	i <sub>ex</sub>	T <sub>2N</sub> (N.m)	f		
2.2	1455	183	100	B80	8	7.93	200	2	MB/EC	S205□□-B80-D□□□-□□100□4B22AL□-D□□□□-0□□
2.2	1455	163	113	B90	9	8.90	200	1.77	MB/EC	S205□□-B90-D□□□-□□100□4B22AL□-D□□□□-0□□
2.2	1455	144	128	C10	10	10.1	200	1.56	MB/EC	S205□□-C10-D□□□-□□100□4B22AL□-D□□□□-0□□
2.2	1455	130	142	C11	11.2	11.2	220	1.55	MB/EC	S205□□-C11-D□□□-□□100□4B22AL□-D□□□□-0□□
2.2	1455	114	162	C13	12.5	12.8	220	1.36	MB/EC	S205□□-C13-D□□□-□□100□4B22AL□-D□□□□-0□□
2.2	1455	103	179	C14	14	14.1	220	1.23	MB/EC	S205□□-C14-D□□□-□□100□4B22AL□-D□□□□-0□□
2.2	1455	92.1	200	C16	16	15.8	220	1.1	MB/EC	S205□□-C16-D□□□-□□100□4B22AL□-D□□□□-0□□
2.2	1455	77.4	208	C18	18	18.8	220	1.06	MB/EC	S205□□-C18-D□□□-□□100□4B22AL□-D□□□□-0□□
2.2	1455	69	234	C20	20	21.1	220	0.94	MB/EC	S205□□-C20-D□□□-□□100□4B22AL□-D□□□□-0□□
2.2	1455	61.1	264	C22	22.4	23.8	230	0.87	MB/EC	S205□□-C22-D□□□-□□100□4B22AL□-D□□□□-0□□
2.2	1455	55.1	293	C25	25	26.4	250	0.85	MB/EC	S205□□-C25-D□□□-□□100□4B22AL□-D□□□□-0□□
2.2	1455	81.3	198	C18	18	17.9	450	2.27	MB/EC	S206□□-C18-D□□□-□□100□4B22AL□-D□□□□-0□□
2.2	1455	71	227	C20	20	20.5	450	1.98	MB/EC	S206□□-C20-D□□□-□□100□4B22AL□-D□□□□-0□□
2.2	1455	62.4	258	C22	22.4	23.3	450	1.74	MB/EC	S206□□-C22-D□□□-□□100□4B22AL□-D□□□□-0□□
2.2	1455	55.7	289	C25	25	26.1	450	1.56	MB/EC	S206□□-C25-D□□□-□□100□4B22AL□-D□□□□-0□□
2.2	1455	50	323	C28	28	29.1	450	1.39	MB/EC	S206□□-C28-D□□□-□□100□4B22AL□-D□□□□-0□□
2.2	1455	45.6	354	C32	31.5	31.9	480	1.36	MB/EC	S206□□-C32-D□□□-□□100□4B22AL□-D□□□□-0□□
2.2	1455	40.1	402	C36	35.5	36.3	480	1.19	MB/EC	S206□□-C36-D□□□-□□100□4B22AL□-D□□□□-0□□
2.2	1455	36.6	440	C40	40	39.7	480	1.09	MB/EC	S206□□-C40-D□□□-□□100□4B22AL□-D□□□□-0□□
2.2	1455	32.3	500	C45	45	45.1	510	1.02	MB/EC	S206□□-C45-D□□□-□□100□4B22AL□-D□□□□-0□□
2.2	1455	30.3	532	C50	50	48.0	540	1.02	MB/EC	S206□□-C50-D□□□-□□100□4B22AL□-D□□□□-0□□
2.2	1455	27	480	C56	56	53.8	480	1	MB/EC	S206□□-C56-D□□□-□□100□4B22AL□-D□□□□-0□□
2.2	1455	23.6	550	C63	63	61.6	500	0.91	MB/EC	S206□□-C63-D□□□-□□100□4B22AL□-D□□□□-0□□
2.2	1455	20.8	625	C71	71	70.0	500	0.8	MB/EC	S206□□-C71-D□□□-□□100□4B22AL□-D□□□□-0□□
2.2	1455	25.3	514	C56	56	57.6	1000	1.95	MB/EC	S207□□-C56-D□□□-□□100□4B22AL□-D□□□□-0□□
2.2	1455	22.5	579	C63	63	64.8	1100	1.9	MB/EC	S207□□-C63-D□□□-□□100□4B22AL□-D□□□□-0□□
2.2	1455	20.5	633	C71	71	70.9	1100	1.74	MB/EC	S207□□-C71-D□□□-□□100□4B22AL□-D□□□□-0□□
2.2	1455	17.5	744	C80	80	83.3	1100	1.48	MB/EC	S207□□-C80-D□□□-□□100□4B22AL□-D□□□□-0□□
2.2	1455	15.8	820	C90	90	91.9	1100	1.34	MB/EC	S207□□-C90-D□□□-□□100□4B22AL□-D□□□□-0□□
2.2	1455	13.8	942	D10	100	105.5	1200	1.27	MB/EC	S207□□-D10-D□□□-□□100□4B22AL□-D□□□□-0□□
2.2	1455	12.3	1059	D11	112	118.6	1200	1.13	MB/EC	S207□□-D11-D□□□-□□100□4B22AL□-D□□□□-0□□
2.2	1455	11	1088	D13	125	132.6	1200	1.1	MB/EC	S207□□-D13-D□□□-□□100□4B22AL□-D□□□□-0□□
2.2	1455	9.9	1212	D14	140	147.6	1300	1.07	MB/EC	S207□□-D14-D□□□-□□100□4B22AL□-D□□□□-0□□
2.2	1455	9	1328	D16	160	161.8	1300	0.98	MB/EC	S207□□-D16-D□□□-□□100□4B22AL□-D□□□□-0□□
2.2	1455	8.3	1444	D18	180	175.9	1300	0.9	MB/EC	S207□□-D18-D□□□-□□100□4B22AL□-D□□□□-0□□
2.2	1455	7.4	1623	D20	200	197.7	1300	0.8	MB/EC	S207□□-D20-D□□□-□□100□4B22AL□-D□□□□-0□□
2.2	1455	9.9	1203	D14	140	146.6	2100	1.75	MB/EC	S208□□-D14-D□□□-□□100□4B22AL□-D□□□□-0□□
2.2	1455	9.3	1283	D16	160	156.3	2200	1.71	MB/EC	S208□□-D16-D□□□-□□100□4B22AL□-D□□□□-0□□
2.2	1455	8.1	1482	D18	180	180.5	2300	1.55	MB/EC	S208□□-D18-D□□□-□□100□4B22AL□-D□□□□-0□□
2.2	1455	7.1	1684	D20	200	205.2	2300	1.37	MB/EC	S208□□-D20-D□□□-□□100□4B22AL□-D□□□□-0□□
2.2	1455	6.4	1871	D22	224	228.0	2300	1.23	MB/EC	S208□□-D22-D□□□-□□100□4B22AL□-D□□□□-0□□
2.2	1455	5.7	2105	D25	250	256.5	2300	1.09	MB/EC	S208□□-D25-D□□□-□□100□4B22AL□-D□□□□-0□□
2.2	1455	5.2	2316	D28	280	282.2	2300	0.99	MB/EC	S208□□-D28-D□□□-□□100□4B22AL□-D□□□□-0□□
2.2	1455	4.7	2531	D32	315	308.3	2300	0.91	MB/EC	S208□□-D32-D□□□-□□100□4B22AL□-D□□□□-0□□

马达 额定功率	马达 额定转速	减速机实际 输出转速	减速机实际 输出扭矩	减速机公称 减速比代号	减速机公称 减速比	减速机精确 减速比	减速机额定 输出扭矩	服务系数	通讯方式	订货号
Motor Rated Power	Motor Rated Speed	Actual Output Speed of Gearmotor	Actual Output Torque of Gearmotor	Nominal Ratio Code of Gearmotor	Nominal Ratio of Gearmotor	Exact Ratio of Gearmotor	Normal Output Torque of Gearmotor	Service Coefficient	Communication Mode	Order Code
P <sub>IN</sub> (kw)	n <sub>1N</sub> (r/min)	n <sub>2N</sub> (r/min)	T <sub>2</sub> (N.m)	Code	i <sub>N</sub>	i <sub>ex</sub>	T <sub>2N</sub> (N.m)	f		
3	1455	207	122	B71	7.1	7.03	330	2.7	MB/EC	S206□□-B71-D□□□-□□100□4B30AL□-D□□□□-0□□
3	1455	174	145	B80	8	8.37	350	2.41	MB/EC	S206□□-B80-D□□□-□□100□4B30AL□-D□□□□-0□□
3	1455	156	162	B90	9	9.32	380	2.35	MB/EC	S206□□-B90-D□□□-□□100□4B30AL□-D□□□□-0□□
3	1455	141	179	C10	10	10.3	380	2.12	MB/EC	S206□□-C10-D□□□-□□100□4B30AL□-D□□□□-0□□
3	1455	125	201	C11	11.2	11.6	380	1.89	MB/EC	S206□□-C11-D□□□-□□100□4B30AL□-D□□□□-0□□
3	1455	115	220	C13	12.5	12.7	400	1.82	MB/EC	S206□□-C13-D□□□-□□100□4B30AL□-D□□□□-0□□
3	1455	100	251	C14	14	14.5	430	1.71	MB/EC	S206□□-C14-D□□□-□□100□4B30AL□-D□□□□-0□□
3	1455	94.5	267	C16	16	15.4	450	1.69	MB/EC	S206□□-C16-D□□□-□□100□4B30AL□-D□□□□-0□□
3	1455	81.3	272	C18	18	17.9	450	1.65	MB/EC	S206□□-C18-D□□□-□□100□4B30AL□-D□□□□-0□□
3	1455	71	311	C20	20	20.5	450	1.45	MB/EC	S206□□-C20-D□□□-□□100□4B30AL□-D□□□□-0□□
3	1455	62.4	353	C22	22.4	23.3	450	1.27	MB/EC	S206□□-C22-D□□□-□□100□4B30AL□-D□□□□-0□□
3	1455	55.7	396	C25	25	26.1	450	1.14	MB/EC	S206□□-C25-D□□□-□□100□4B30AL□-D□□□□-0□□
3	1455	50	441	C28	28	29.1	450	1.02	MB/EC	S206□□-C28-D□□□-□□100□4B30AL□-D□□□□-0□□
3	1455	45.6	484	C32	31.5	31.9	480	0.99	MB/EC	S206□□-C32-D□□□-□□100□4B30AL□-D□□□□-0□□
3	1455	40.1	551	C36	35.5	36.3	480	0.87	MB/EC	S206□□-C36-D□□□-□□100□4B30AL□-D□□□□-0□□
3	1455	36.6	602	C40	40	39.7	480	0.8	MB/EC	S206□□-C40-D□□□-□□100□4B30AL□-D□□□□-0□□
3	1455	48.3	457	C32	31.5	30.1	1100	2.41	MB/EC	S207□□-C32-D□□□-□□100□4B30AL□-D□□□□-0□□
3	1455	42.2	523	C36	35.5	34.5	1100	2.1	MB/EC	S207□□-C36-D□□□-□□100□4B30AL□-D□□□□-0□□
3	1455	37.5	589	C40	40	38.8	1100	1.87	MB/EC	S207□□-C40-D□□□-□□100□4B30AL□-D□□□□-0□□
3	1455	33.5	658	C45	45	43.4	1100	1.67	MB/EC	S207□□-C45-D□□□-□□100□4B30AL□-D□□□□-0□□
3	1455	30.1	733	C50	50	48.3	1100	1.5	MB/EC	S207□□-C50-D□□□-□□100□4B30AL□-D□□□□-0□□
3	1455	25.3	704	C56	56	57.6	1000	1.42	MB/EC	S207□□-C56-D□□□-□□100□4B30AL□-D□□□□-0□□
3	1455	22.5	791	C63	63	64.8	1100	1.39	MB/EC	S207□□-C63-D□□□-□□100□4B30AL□-D□□□□-0□□
3	1455	20.5	866	C71	71	70.9	1100	1.27	MB/EC	S207□□-C71-D□□□-□□100□4B30AL□-D□□□□-0□□
3	1455	17.5	1017	C80	80	83.3	1100	1.08	MB/EC	S207□□-C80-D□□□-□□100□4B30AL□-D□□□□-0□□
3	1455	15.8	1122	C90	90	91.9	1100	0.98	MB/EC	S207□□-C90-D□□□-□□100□4B30AL□-D□□□□-0□□
3	1455	13.8	1289	D10	100	105.5	1200	0.93	MB/EC	S207□□-D10-D□□□-□□100□4B30AL□-D□□□□-0□□
3	1455	12.3	1449	D11	112	118.6	1200	0.83	MB/EC	S207□□-D11-D□□□-□□100□4B30AL□-D□□□□-0□□
3	1455	11	1489	D13	125	132.6	1200	0.81	MB/EC	S207□□-D13-D□□□-□□100□4B30AL□-D□□□□-0□□
3	1455	16.6	1071	C90	90	87.7	1900	1.77	MB/EC	S208□□-C90-D□□□-□□100□4B30AL□-D□□□□-0□□
3	1455	14.1	1257	D10	100	102.9	2000	1.59	MB/EC	S208□□-D10-D□□□-□□100□4B30AL□-D□□□□-0□□
3	1455	12.6	1413	D11	112	115.7	2000	1.42	MB/EC	S208□□-D11-D□□□-□□100□4B30AL□-D□□□□-0□□
3	1455	11.5	1425	D13	125	126.9	2000	1.4	MB/EC	S208□□-D13-D□□□-□□100□4B30AL□-D□□□□-0□□
3	1455	9.9	1646	D14	140	146.6	2100	1.28	MB/EC	S208□□-D14-D□□□-□□100□4B30AL□-D□□□□-0□□
3	1455	9.3	1755	D16	160	156.3	2200	1.25	MB/EC	S208□□-D16-D□□□-□□100□4B30AL□-D□□□□-0□□
3	1455	8.1	2027	D18	180	180.5	2300	1.13	MB/EC	S208□□-D18-D□□□-□□100□4B30AL□-D□□□□-0□□
3	1455	7.1	2304	D20	200	205.2	2300	1	MB/EC	S208□□-D20-D□□□-□□100□4B30AL□-D□□□□-0□□
3	1455	6.4	2560	D22	224	228.0	2300	0.9	MB/EC	S208□□-D22-D□□□-□□100□4B30AL□-D□□□□-0□□
3	1455	5.7	2880	D25	250	256.5	2300	0.8	MB/EC	S208□□-D25-D□□□-□□100□4B30AL□-D□□□□-0□□

## 6.外形尺寸图(mm)

## 6. Dimensions (mm)

### S203

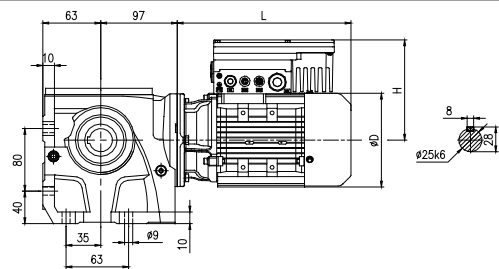

Horizontal foot-mounted H

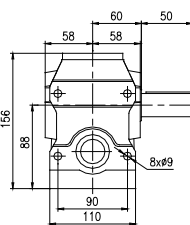

S203HA

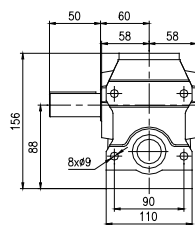

S203HB

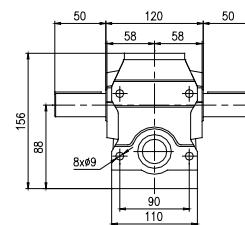

S203HC

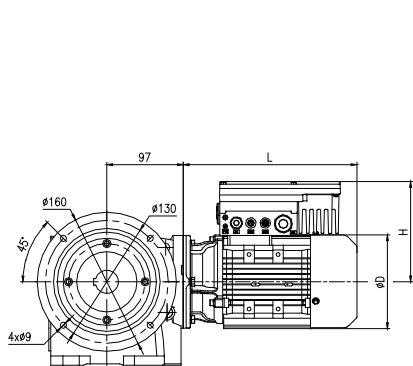

Flange-mounted F

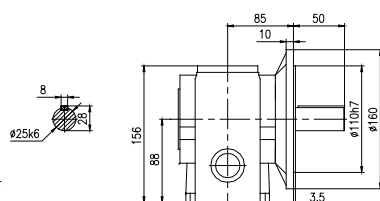

S203FA

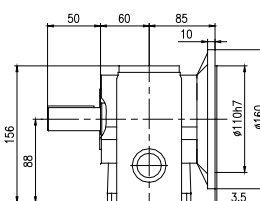

S203FB

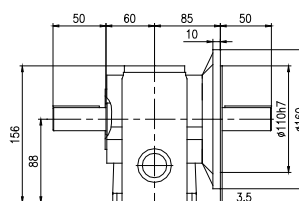

S203FC

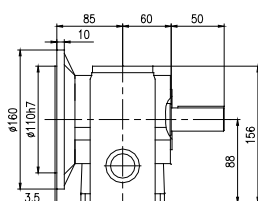

S203FD

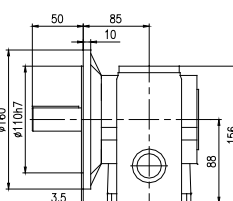

S203FE

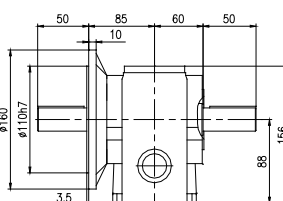

S203FF

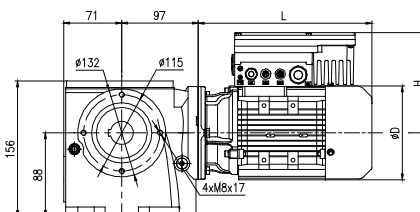

Short flange-mounted S

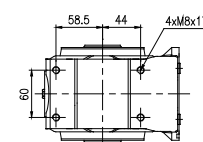

Shaft-mounted A

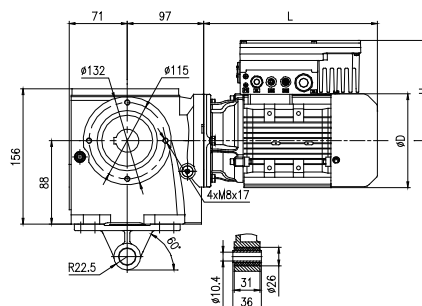

Torque arm-mounted with accessory T

Dimension Data of Gearmotor Variable Frequency Drive All-in-one (mm) 50Hz-1500r/min

Power of 4 pole type (kW)	Range of Ratio	MH			MP		
		L	D	H	L	D	H
0.25	7.1-100	223	138	151.5	223	138	151.5
0.37	7.1-63	223	138	151.5	223	138	151.5
0.55	7.1-35.5	299	159	173	299	159	173
0.75	7.1-25	299	159	173	299	159	173

## S203

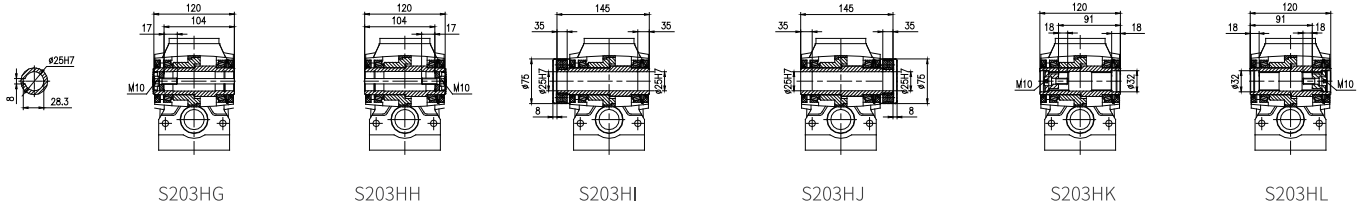

S203HG

S203HH

S203HI

S203HJ

S203HK

S203HL

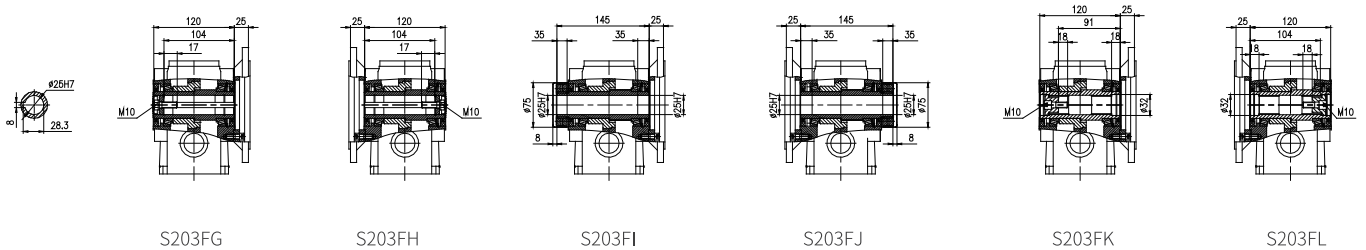

S203FG

S203FH

S203FI

S203FJ

S203FK

S203FL

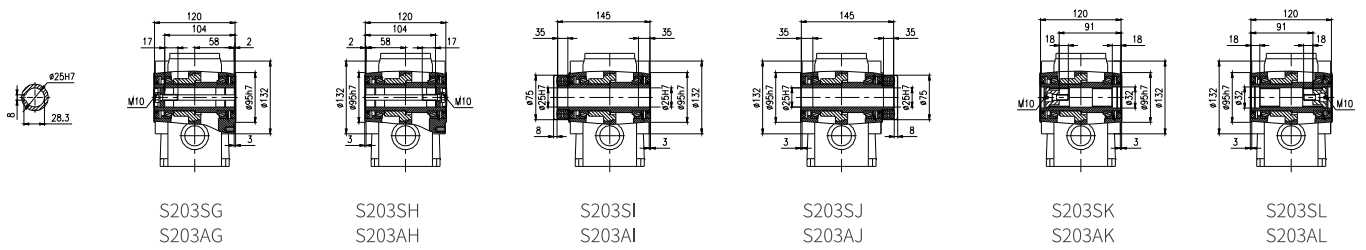

S203SG  
S203AG

S203SH  
S203AH

S203SI  
S203AI

S203SJ  
S203AJ

S203SK  
S203AK

S203SL  
S203AL

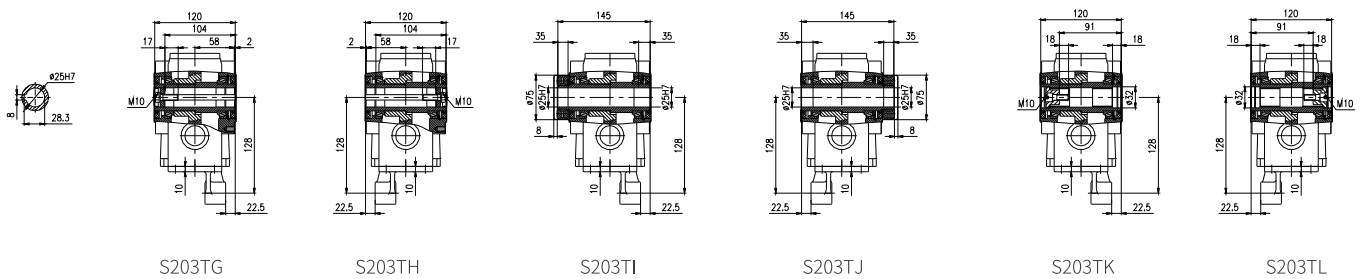

S203TG

S203TH

S203TI

S203TJ

S203TK

S203TL

## S204

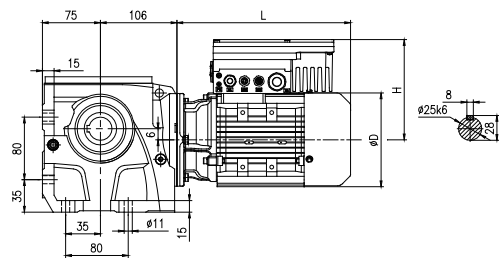

Horizontal foot-mounted H

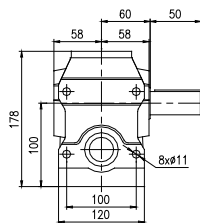

S204HA

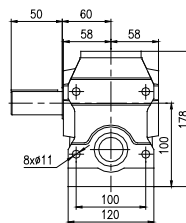

S204HB

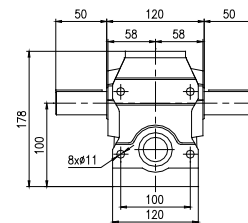

S204HC

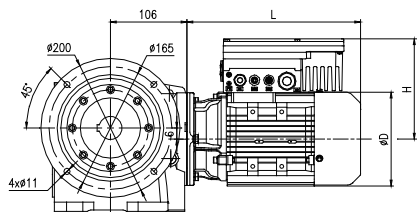

Flange-mounted F

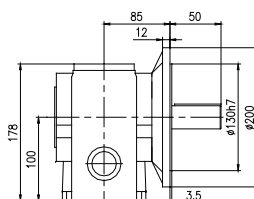

S204FA

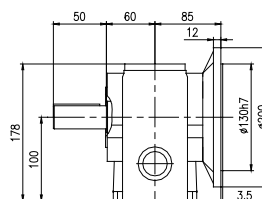

S204FB

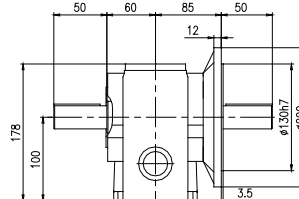

S204FC

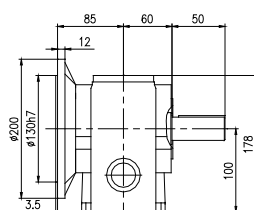

S204FD

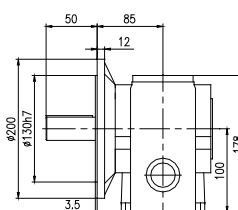

S204FE

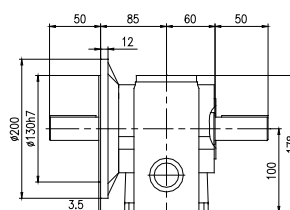

S204FF

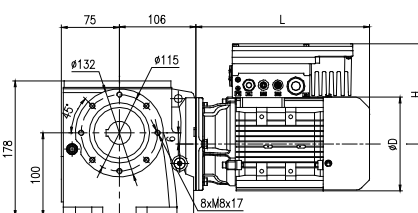

Short flange-mounted S

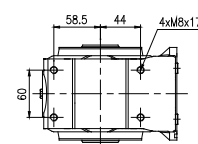

Shaft-mounted A

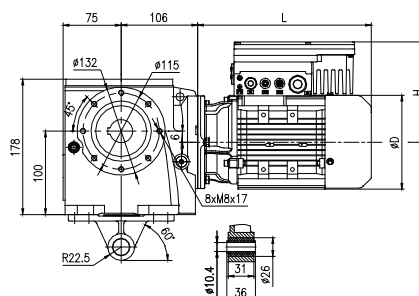

Torque arm-mounted with accessory T

Dimension Data of Gearmotor Variable Frequency Drive All-in-one (mm) 50Hz-1500r/min							
Power of 4 pole type (kW)	Range of Ratio	MH			MP		
		L	D	H	L	D	H
0.25	80-224	223	138	151.5	223	138	151.5
0.37	45-140	223	138	151.5	223	138	151.5
0.55	28-90	299	159	173	299	159	173
0.75	16-63	299	159	173	299	159	173
1.1	7.1-35.5	321	176	188.5	321	176	188.5
1.5	7.1-25	321	176	188.5	346	176	188.5

## S204

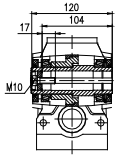

S204HG

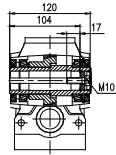

S204HH

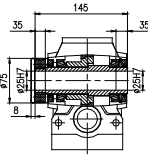

S204HI

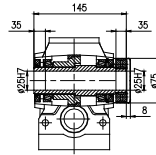

S204HJ

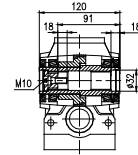

S204HK

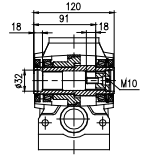

S204HL

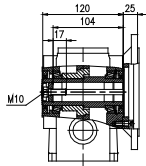

S204FG

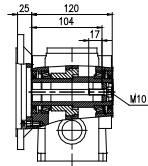

S204FH

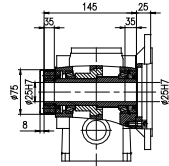

S204FI

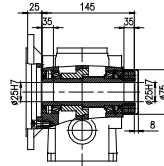

S204FJ

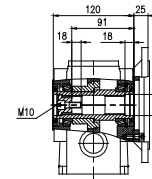

S204FK

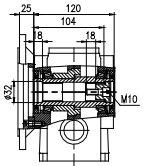

S204FL

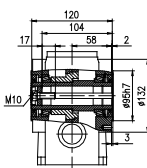

S204SG  
S204AG

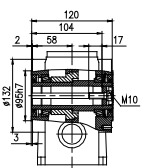

S204SH  
S204AH

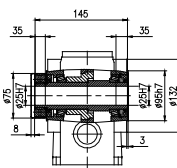

S204SI  
S204AI

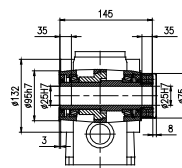

S204SJ  
S204AJ

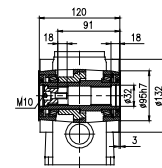

S204SK  
S204AK

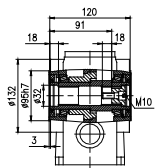

S204SL  
S204AL

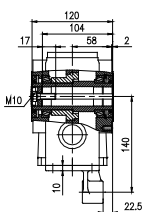

S204TG

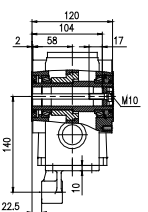

S204TH

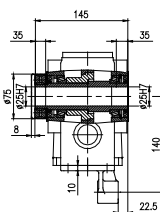

S204TI

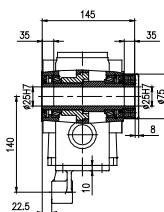

S204TJ

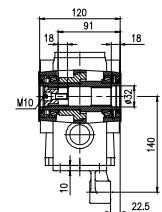

S204TK

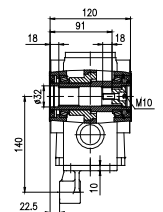

S204TL

## S205

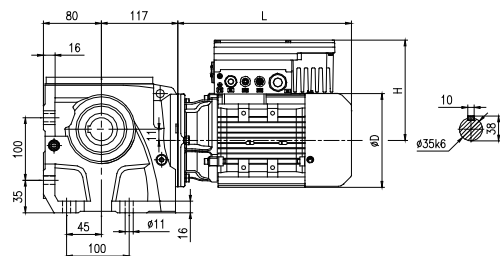

Horizontal foot-mounted H

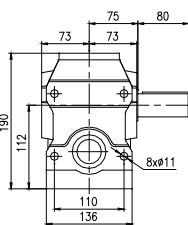

S205HA

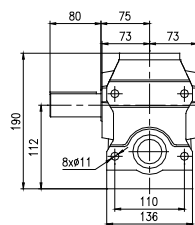

S205HB

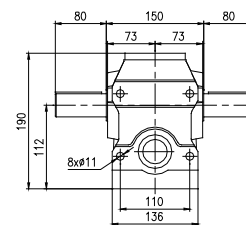

S205HC

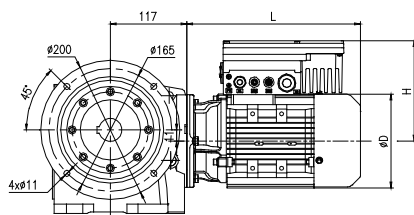

Flange-mounted F

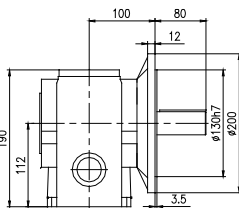

S205FA

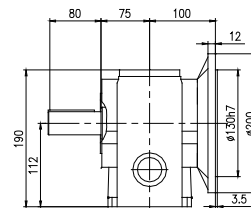

S205FB

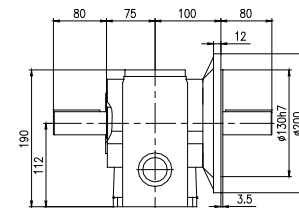

S205FC

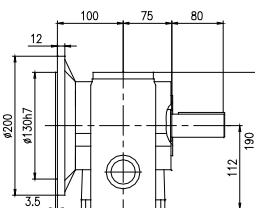

S205FD

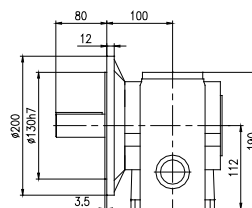

S205FE

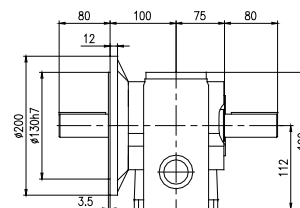

S205FF

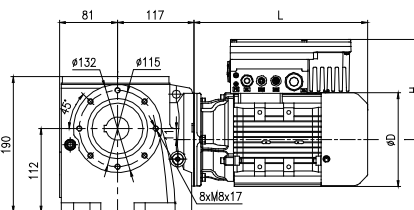

Short flange-mounted S

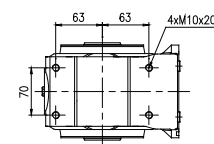

Shaft-mounted A

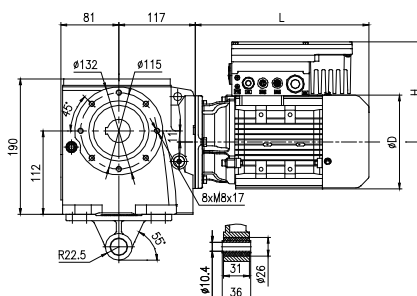

Torque arm-mounted with accessory T

Dimension Data of Gearmotor Variable Frequency Drive All-in-one (mm) 50Hz-1500r/min								
Power of 4 pole type (kW)	Range of Ratio	MH			MP			H
		L	D	H	L	D	H	
0.37	100-224	224	138	151.5	224	138	151.5	
0.55	71-180	300	159	173	300	159	173	
0.75	40-125	300	159	173	300	159	173	
1.1	25-80	323	176	188.5	323	176	188.5	
1.5	12.5-40	323	176	188.5	348	176	188.5	
2.2	8-25	395	198	191	395	198	191	

## S205

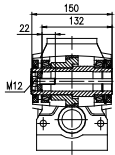
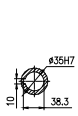

S205HG

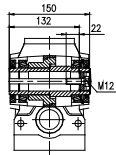

S205HH

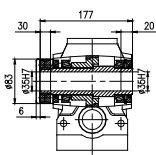

S205HI

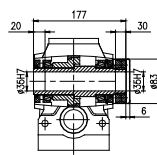

S205HJ

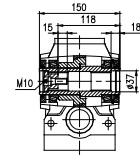

S205HK

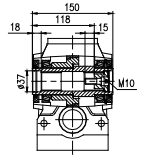

S205HL

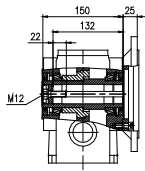

S205FG

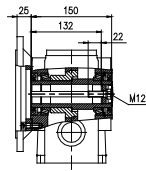

S205FH

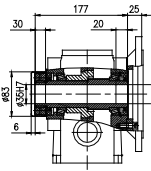

S205FI

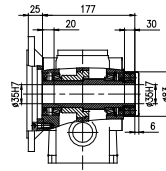

S205FJ

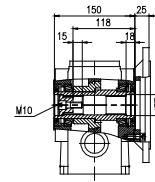

S205FK

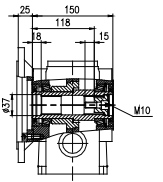

S205FL

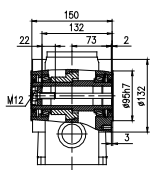

S205SG  
S205AG

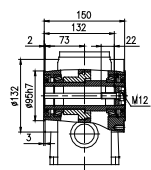

S205SH  
S205AH

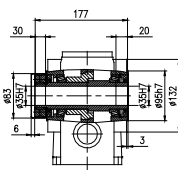

S205SI  
S205AI

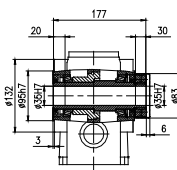

S205SJ  
S205AJ

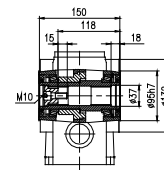

S205SK  
S205AK

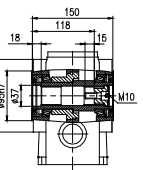

S205SL  
S205AL

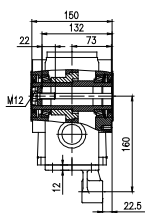

S205TG

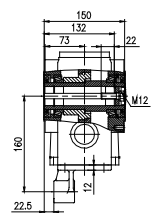

S205TH

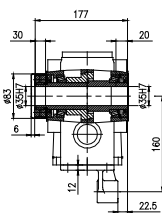

S205TI

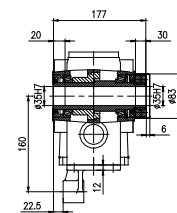

S205TJ

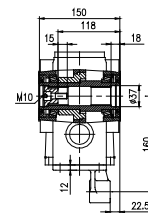

S205TK

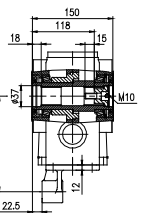

S205TL



## S206

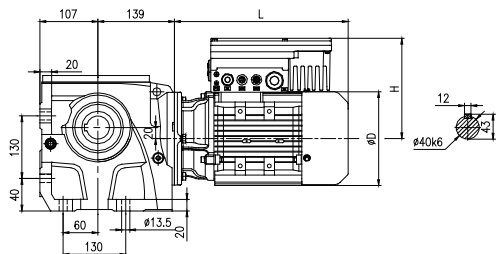

Horizontal foot-mounted H

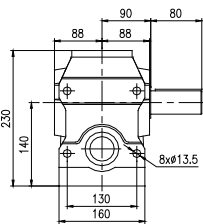

S206HA

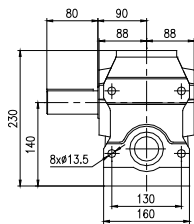

S206HB

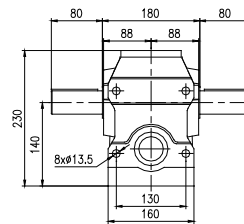

S206HC

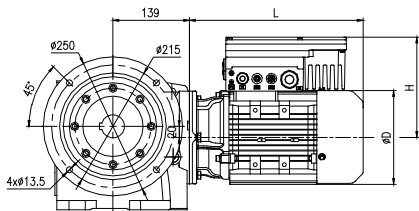

Flange-mounted F

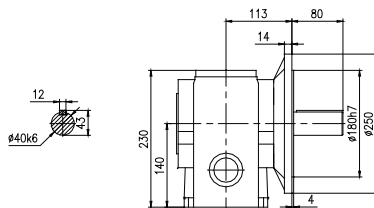

S206FA

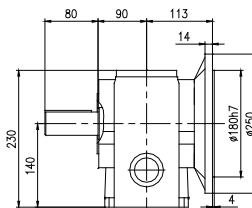

S206FB

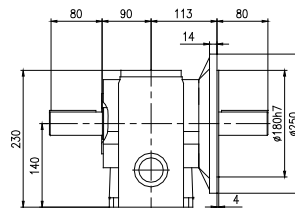

S206FC

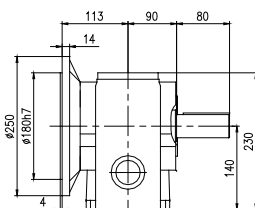

S206FD

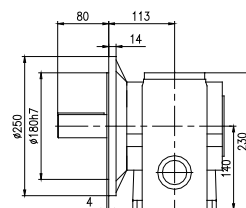

S206FE

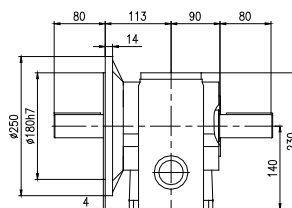

S206FF

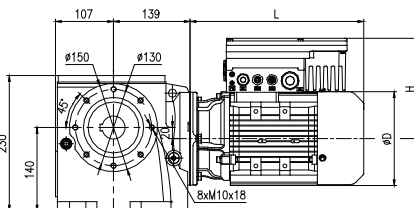

Short flange-mounted S

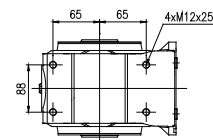

Shaft-mounted A

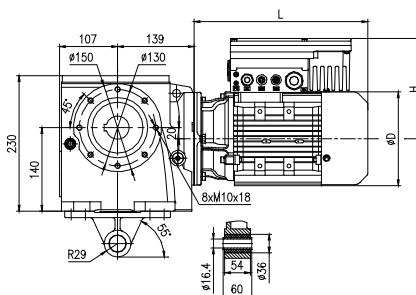

Torque arm-mounted with accessory T

Dimension Data of Gearmotor Variable Frequency Drive All-in-one (mm) 50Hz-1500r/min							
Power of 4 pole type (kW)	Range of Ratio	MH			MP		
		L	D	H	L	D	H
0.55	140~280	300	159	173	300	159	173
0.75	100~224	300	159	173	300	159	173
1.1	50~140	323	176	188.5	323	176	188.5
1.5	31.5~100	323	176	188.5	348	176	188.5
2.2	18~71	395	198	191	395	198	191
3	7.1~40	395	198	191	395	198	191

## S206

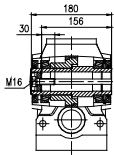

S206HG

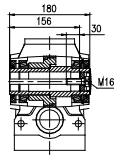

S206HH

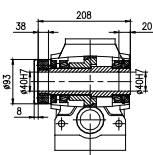

S206HI

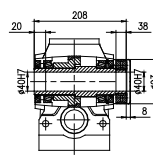

S206HJ

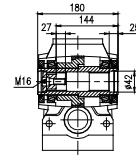

S206HK

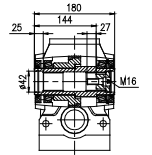

S206HL

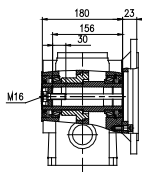

S206FG

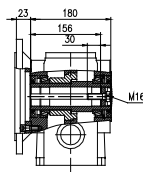

S206FH

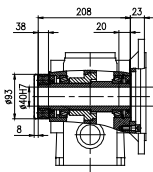

S206FI

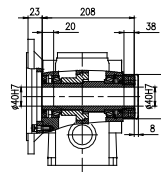

S206FJ

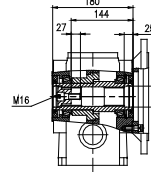

S206FK

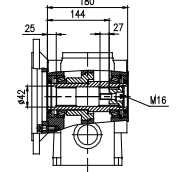

S206FL

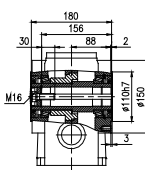

S206SG  
S206AG

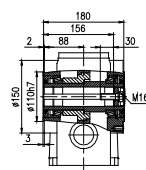

S206SH  
S206AH

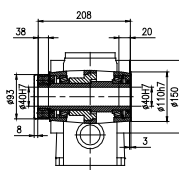

S206SI  
S206AI

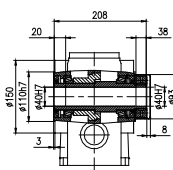

S206SJ  
S206AJ

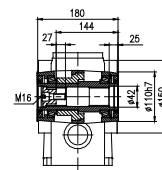

S206SK  
S206AK

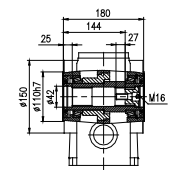

S206SL  
S206AL

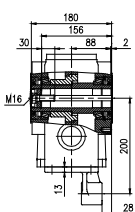

S206TG

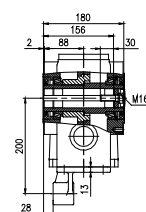

S206TH

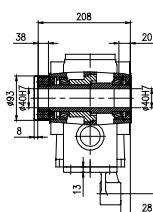

S206TI

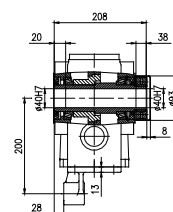

S206TJ

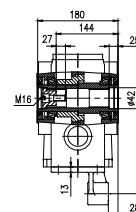

S206TK

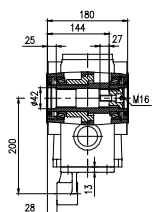

S206TL

## S207

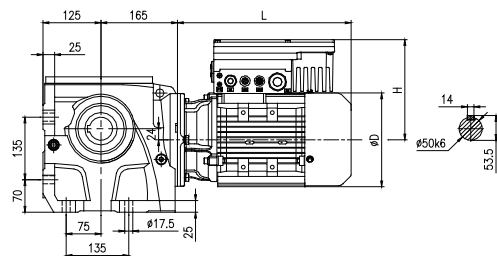

Horizontal foot-mounted H

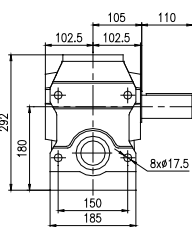

S207HA

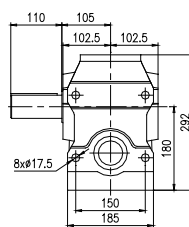

S207HB

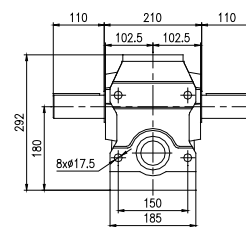

S207HC

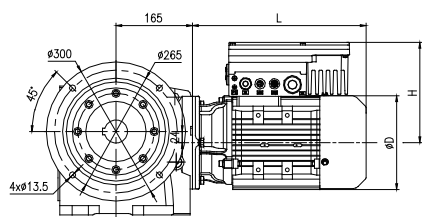

Flange-mounted F

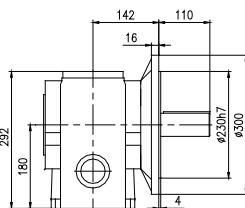

S207FA

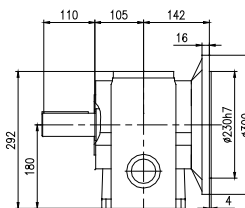

S207FB

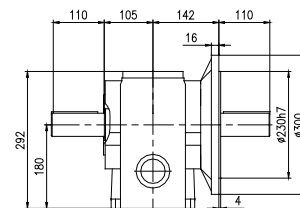

S207FC

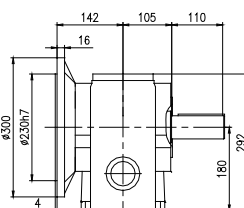

S207FD

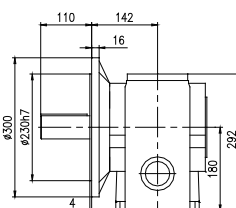

S207FE

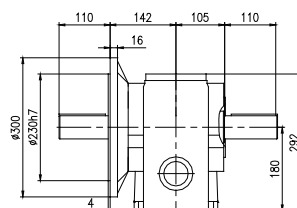

S207FF

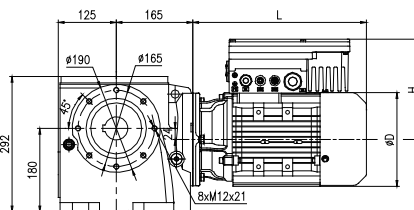

Short flange-mounted S

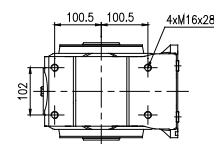

Shaft-mounted A

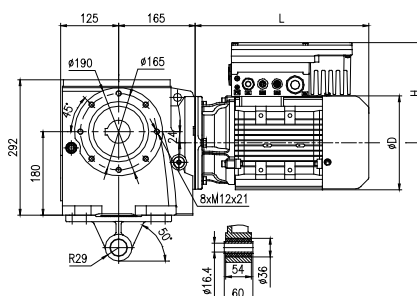

Torque arm-mounted with accessory T

Dimension Data of Gearmotor Variable Frequency Drive  
All-in-one (mm) 50Hz-1500r/min

Power of 4 pole type (kW)	Range of Ratio	MH			MP		
		L	D	H	L	D	H
0.75	180-355	292	159	173	292	159	173
1.1	112-250	314	176	188.5	314	176	188.5
1.5	90-250	314	176	188.5	339	176	188.5
2.2	56-200	387	198	191	387	198	191
3	31.5-125	387	198	191	387	198	191

## S207

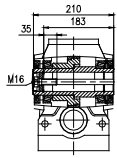

S207HG

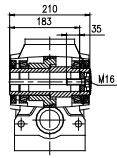

S207HH

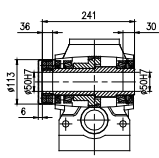

S207HI

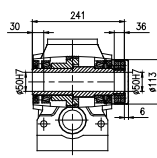

S207HJ

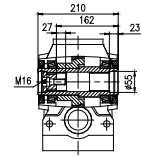

S207HK

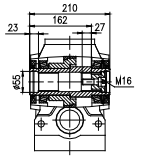

S207HL

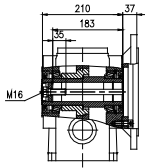

S207FG

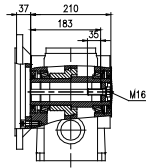

S207FH

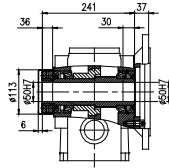

S207FI

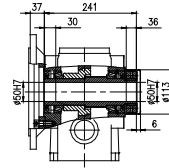

S207FJ

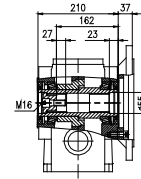

S207FK

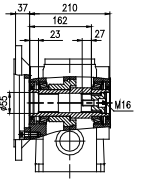

S207FL

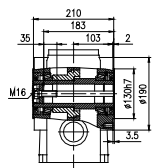

S207SG  
S207AG

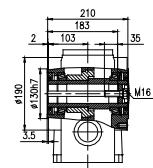

S207SH  
S207AH

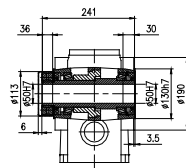

S207SI  
S207AI

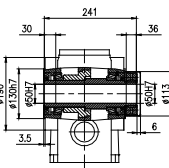

S207SJ  
S207AJ

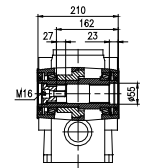

S207SK  
S207AK

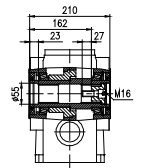

S207SL  
S207AL

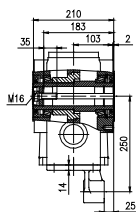

S207TG

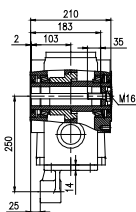

S207TH

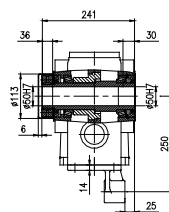

S207TI

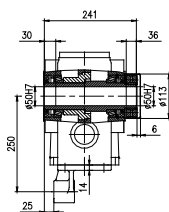

S207TJ

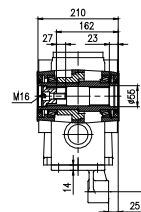

S207TK

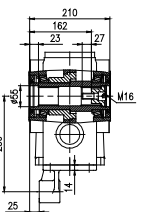

S207TL

## S208

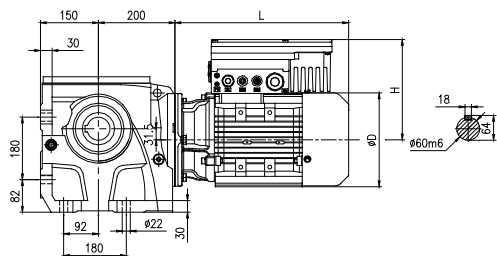

Horizontal foot-mounted H

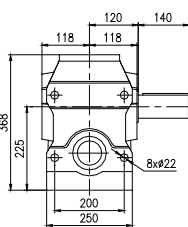

S208HA

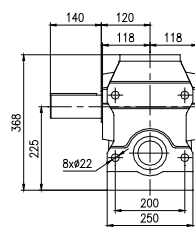

S208HB

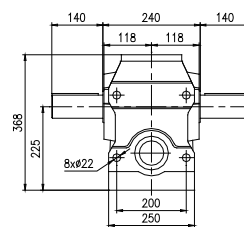

S208HC

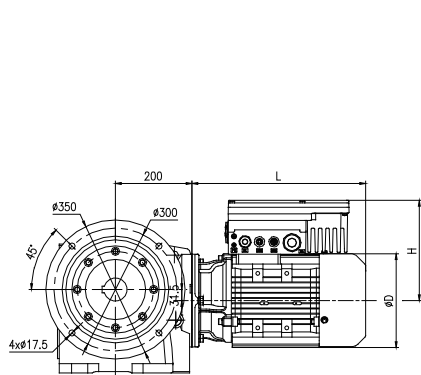

Flange-mounted F

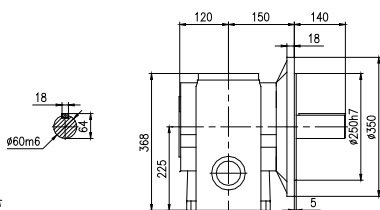

S208FA

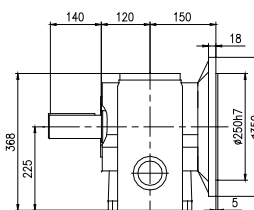

S208FB

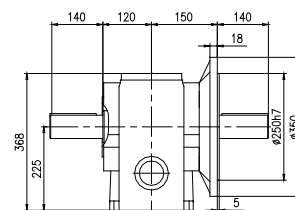

S208FC

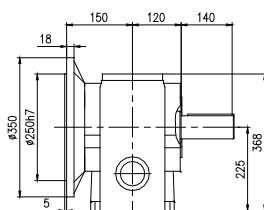

S208FD

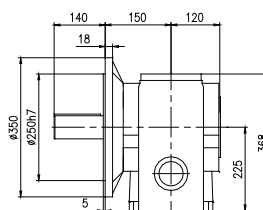

S208FE

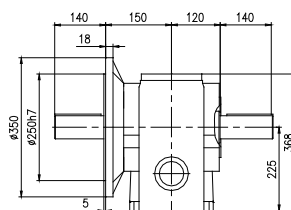

S208FF

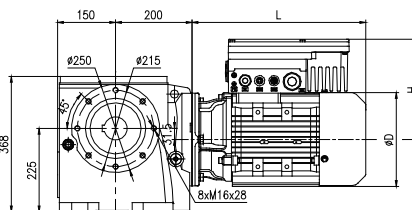

Short flange-mounted S

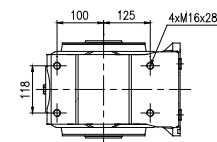

Shaft-mounted A

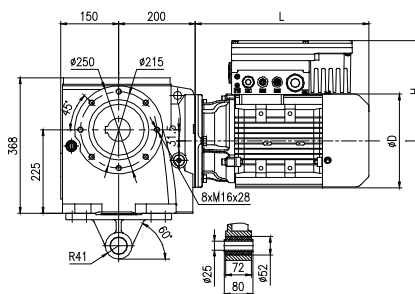

Torque arm-mounted with accessory T

Dimension Data of Gearmotor Variable Frequency Drive  
All-in-one (mm) 50Hz-1500r/min

Power of 4 pole type (kW)	Range of Ratio	MH			MP		
		L	D	H	L	D	H
1.5	224~315	305	176	188.5	330	176	188.5
2.2	140~315	378	198	191	378	198	191
3	90~250	378	198	191	378	198	191

**S208**

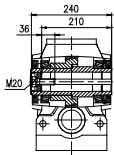

S208HG

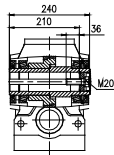

S208HH

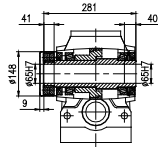

S208HI

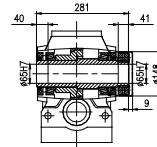

S208HJ

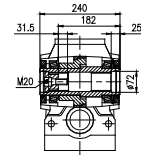

S208HK

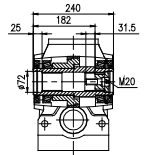

S208HL

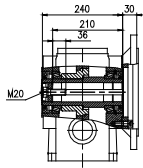

S208FG

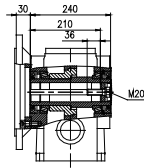

S208FH

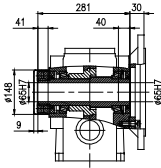

S208FI

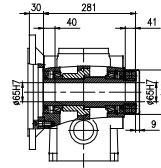

S208FJ

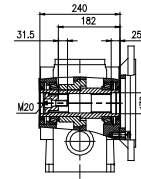

S208FK

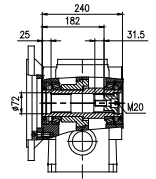

S208FL

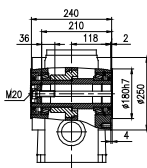

S208SG  
S208AG

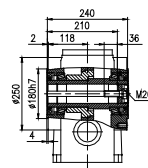

S208SH  
S208AH

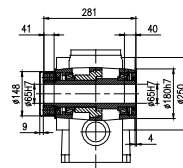

S208SI  
S208AI

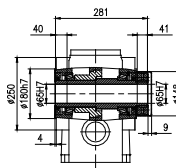

S208SJ  
S208AJ

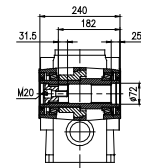

S208SK  
S208AK

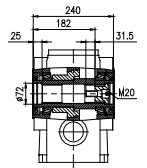

S208SL  
S208AL

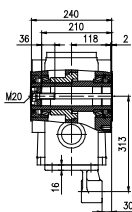

S208TG

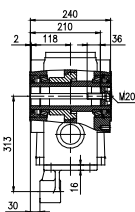

S208TH

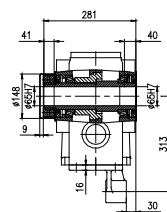

S208TI

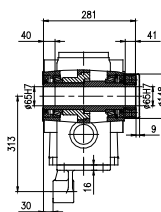

S208TJ

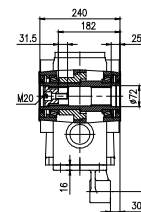

S208TK

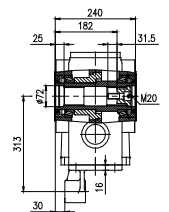

S208TL

**7. 允许的输出轴径向力Fr2(N)**

**7. Permissible Radial Force of Output Shaft Fr2(N)**

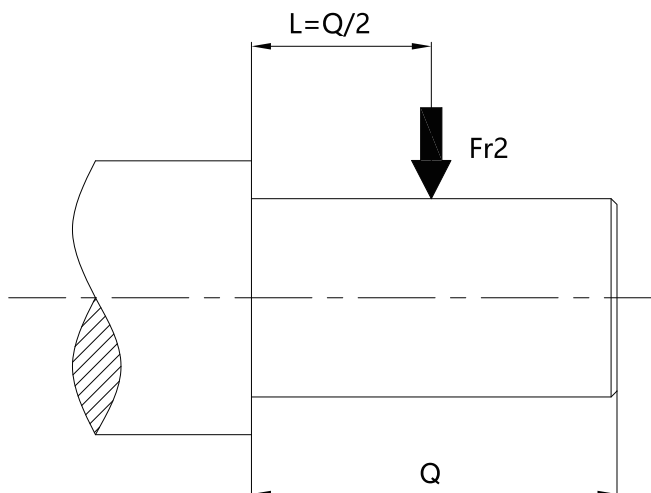

$n_{2N}$ (r/min)	$Fr_2$ (N)					
	S203	S204	S205	S206	S207	S208
200~224	370	520	860	860	870	3170
180~200	460	650	1080	1070	1090	3960
160~180	580	810	1350	1340	1360	4950
125~160	720	1010	1680	1670	1700	6190
112~125	900	1270	2110	2090	2120	7740
100~112	1120	1580	2630	2610	2650	9680
90~100	1400	1980	3290	3270	3310	12100
80~90	1760	2480	4110	4090	4140	15120
56~80	2151	3035	5041	5007	5075	18530
45~56	2380	3332	5542	5304	6265	20995
40~45	2380	3502	5814	5559	6571	22100
35.5~40	2550	3502	5950	6163	6919	23035
31.5~35.5	2550	3766	6222	6163	7438	23970
28~31.5	2550	4004	6392	6851	7659	24650
26.5~28	2550	4123	6392	6851	8203	24650
22.4~26.5	2550	4522	6392	7370	9860	24650
$\leq 22.4$	2550	4556	6392	7378	10455	24650

**8.被驱动轴推荐尺寸(mm)**

**8.Recommended Dimensions for Driven Equipment Shaft(mm)**

**8.1锁紧盘**

**8.1 Shrink Disk**

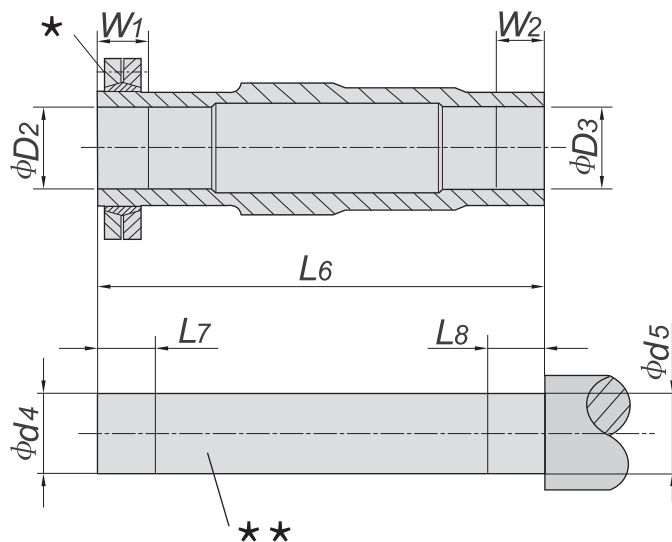

	D2	D3	d4	d5	L6	L7	L8	W1	W2	锁紧盘 型号 Shrink Disk Type	锁紧盘 螺栓 Shrink Disk Bolt	锁紧盘 重量(kg) Shrink Disk Weight (kg)
S203	25H7	25H7	25h6	25h6	145	40	40	35	35	SP2-36×72	M6	0.6
S204	25H7	25H7	25h6	25h6	145	40	40	35	35	SP2-36×72	M6	0.6
S205	35H7	35H7	35h6	35h6	177	35	25	30	20	SP2-44×80	M6	0.8
S206	40H7	40H7	40h6	40h6	208	43	25	38	20	SP2-50×90	M6	0.8
S207	50H7	50H7	50h6	50h6	241	41	35	36	30	SP2-62×110	M6	1.3
S208	65H7	65H7	65h6	65h6	281	46	45	41	40	SP2-80×145	M8	1.9

★ 螺栓

★ Bolt

★★ 被驱动轴

★★ Driven Equipment Shaft



8.2花键轴

8.2 Involute Spline

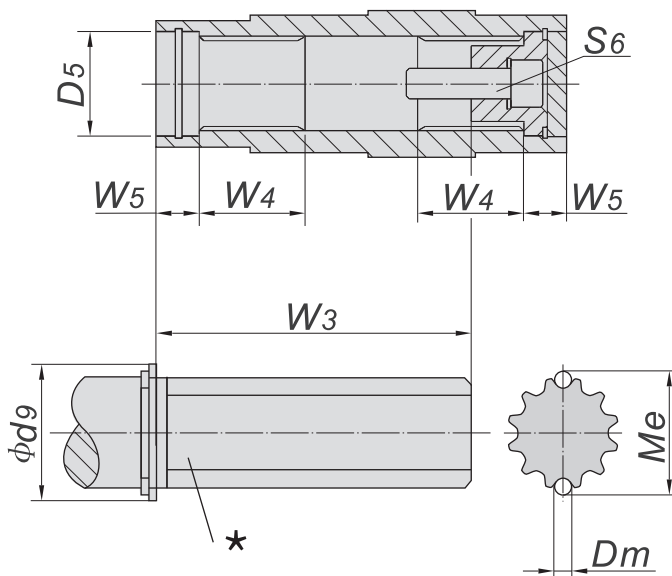

	渐开线花键参数DIN5480 模数x齿数x压力角x大径x9H Involute spline size DIN 5480 m x Z x α x D x 9H	D5	Dm	d9	Me	W3	W4	W5	S6
S203	1.25x18x30x25x9H	32	2.75	37	27.99	90	25	18	M10X30
S204	1.25x18x30x25x9H	32	2.75	37	27.99	90	25	18	M10X30
S205	2x16x30x35x9H	37	4	42	38.92	115	32	18	M10X30
S206	2x16x30x35x9H	42	4	47	38.92	140	42	25	M16X40
S207	2x24x30x50x9H	55	4	62	54.13	160	52	23	M16X50
S208	2x31x30x65x9H	72	4	82	68.96	180	62	25	M20X60

★ 被驱动轴

★ Driven Equipment Shaft

**9.轴端C型螺纹中心孔**

**9.Type C screw central hole in shaft end**

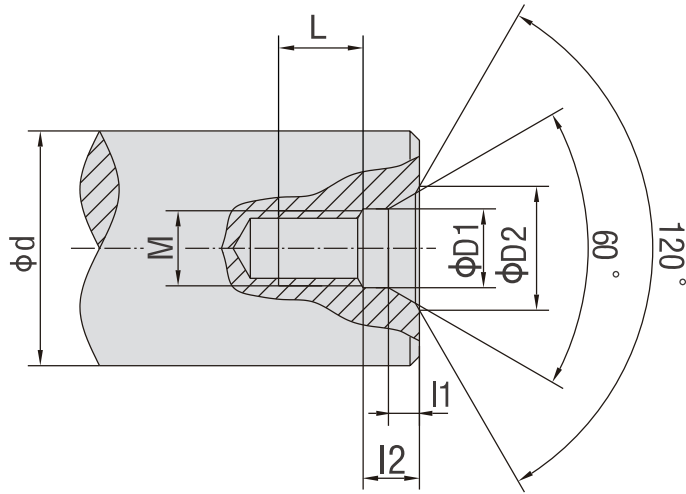

d	M	L	12	11	D1	D2
$7 < d \leq 10$	M3	10	2.6	1.8	3.2	5.8
$10 < d \leq 13$	M4	10	3.2	2.1	4.3	7.4
$13 < d \leq 16$	M5	10	4	2.4	5.3	8.8
$16 < d \leq 21$	M6	12	5	2.8	6.4	10.5
$21 < d \leq 24$	M8	12	6	3.3	8.4	13.2
$24 < d \leq 30$	M10	15	7.5	3.8	10.5	16.3
$30 < d \leq 38$	M12	20	9.5	4.4	13	19.8
$38 < d \leq 50$	M16	25	12	5.2	17	25.3
$50 < d \leq 85$	M20	30	15	6.4	21	31.3
$85 < d \leq 130$	M24	35	18	8	25	38
$130 < d \leq 225$	M30	45	18	11	31	48

**10.平键与键槽的尺寸(mm) 10. Dimension of Parallel Key and Keyway(mm)**

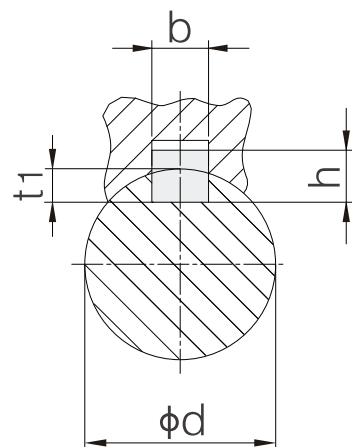
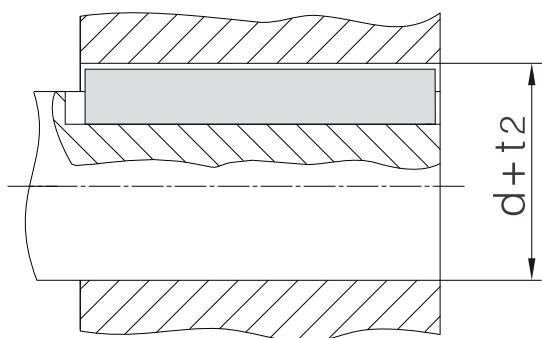

d	b	h	t <sub>1</sub>	d + t <sub>2</sub>
8 < d ≤ 10	3	3	1.8	d + 1.4
10 < d ≤ 12	4	4	2.5	d + 1.8
12 < d ≤ 17	5	5	3	d + 2.3
17 < d ≤ 22	6	6	3.5	d + 2.8
22 < d ≤ 30	8	7	4	d + 3.3
30 < d ≤ 38	10	8	5	d + 3.3
38 < d ≤ 44	12	8	5	d + 3.3
44 < d ≤ 50	14	9	5.5	d + 3.8
50 < d ≤ 58	16	10	6	d + 4.3
58 < d ≤ 65	18	11	7	d + 4.4
65 < d ≤ 75	20	12	7.5	d + 4.9
75 < d ≤ 85	22	14	9	d + 5.4
85 < d ≤ 95	25	14	9	d + 5.4
95 < d ≤ 110	28	16	10	d + 6.4
110 < d ≤ 130	32	18	11	d + 7.4
130 < d ≤ 150	36	20	12	d + 8.4
150 < d ≤ 170	40	22	13	d + 9.4
170 < d ≤ 200	45	25	15	d + 10.4
200 < d ≤ 230	50	28	17	d + 11.4
230 < d ≤ 260	56	32	20	d + 12.4

## 11. 可选附件和指定配置

## 11. Accessories and Specific Configuration

### 11.1 补偿油箱 (代号6)

### 11.1 Oil Compensating Tank (Code 6)

齿轮马达在以下工况时建议采用补偿油箱浸油润滑。

Oil compensating tank lubrication is recommended for gearmotor under working conditions below.

1. 在安装方位为D4且长时间连续运转时，建议配置补偿油箱；
2. 在安装方位为D5/D6时，出厂已配置补偿油箱；

1. Oil compensating tank is recommended for gearmotors with D4 installation position and long duration continuous operation;
2. Oil compensating tank has been equipped for gearmotors with D5 or D6 installation position before delivery.

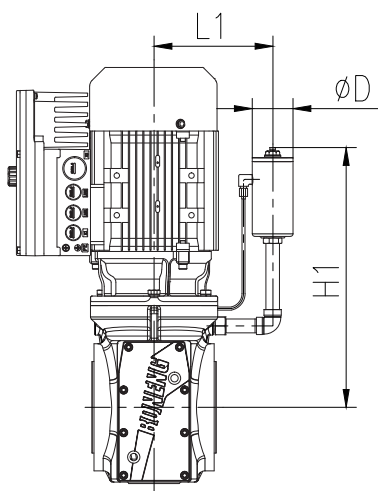

D4

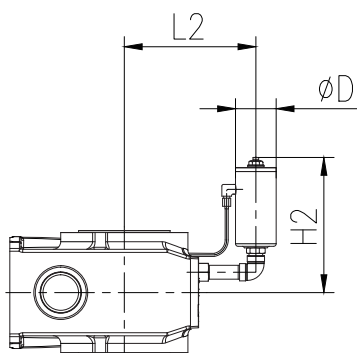

D5

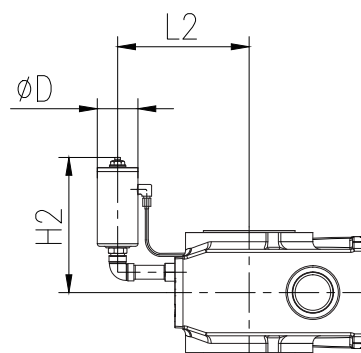

D6

	D	L1	H1	L2	H2
S203	42	110	260	170	140
S204	42	110	265	175	160
S205	42	120	275	180	160
S206	42	130	300	190	165
S207	80	170	470	285	270
S208	80	190	500	325	275

**12.不同安装方位的  
润滑油用量 ( L )**

**12.The oil quantities on dif-  
ferent mounting positon ( L )**

	D1	D2	D3	D4	D5	D6
S203	0.3	0.5	0.6	0.7	0.5	0.5
S204	0.5	1.1	1.1	1.4	1.2	1.2
S205	0.6	1.4	1.2	1.9	1.7	1.7
S206	1.2	2.6	3.7	3.8	3.2	3.2
S207	2.3	5.0	7.0	7.8	5.9	5.9
S208	4.6	9.7	12.5	14.4	10.9	10.9

**13.重量表**

**13. Weight**

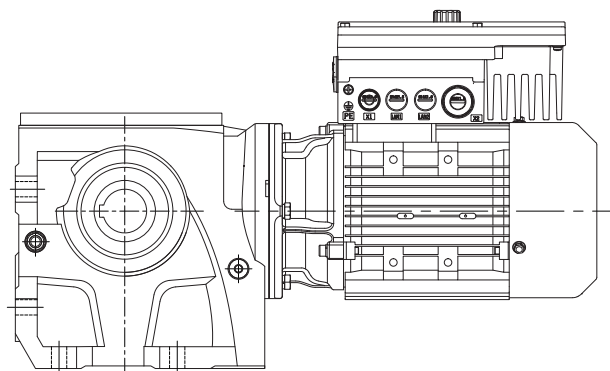

S203	S204	S205	S206	S207	S208			
8.5	13	18	30	52.5	98			
	071M	071M	080M	080M	090S	090M	100M	100M
	0.25	0.37	0.55	0.75	1.1	1.5	2.2	3
MH	8	9	14	15	18	19	30	33
MP	9	10	15	16	21	23	32	36

随着技术迭代进步，博能产品样本将会同步更新，请见谅。  
Along with the technology advancedet.,the product of  
the manual of Boneng will be changed,please forgive.

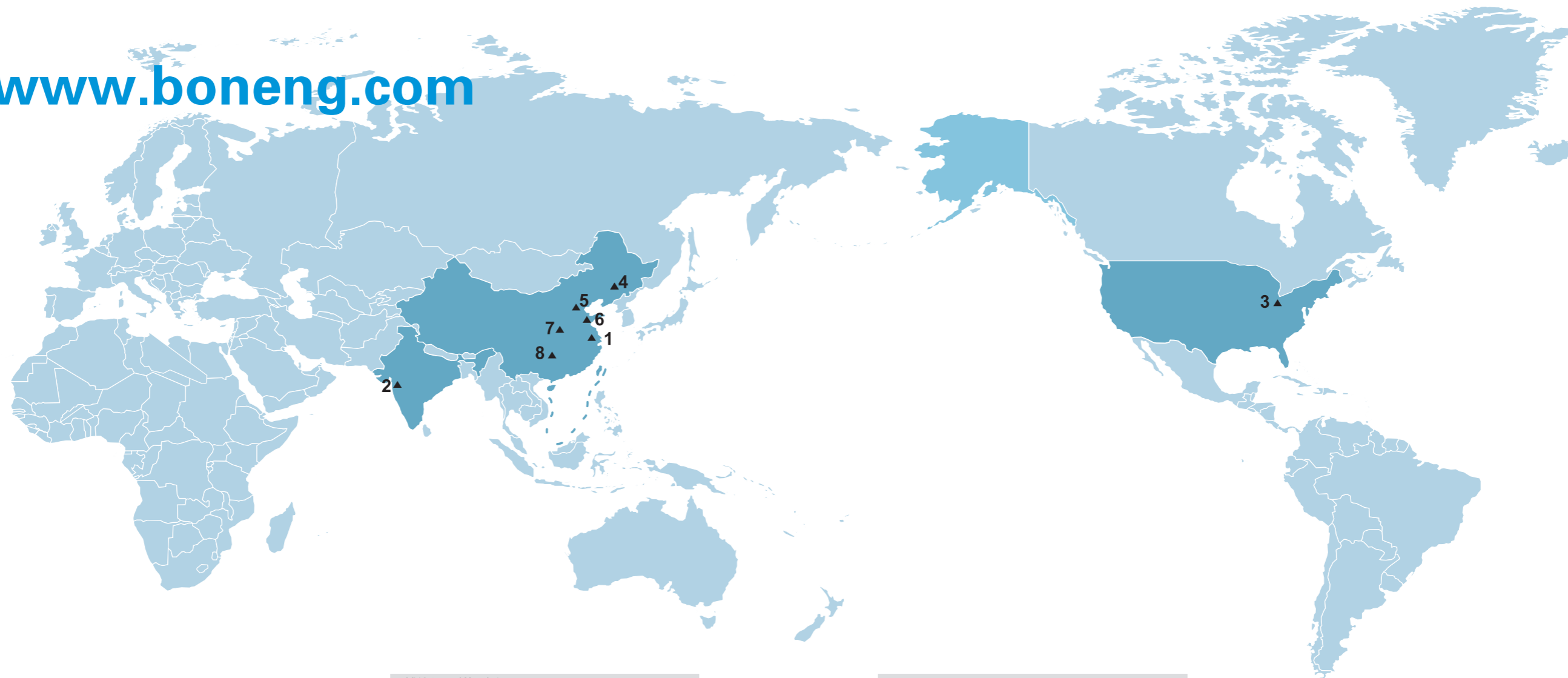

**1 博能传动(苏州)有限公司**  
江苏省苏州市相城区如元路100号 215131  
TEL: 0512-66189662

**2 博能传动(印度)有限公司**  
Plot No. E-10/3, MIDC sinnar (Malegaon)  
Industrial Area, Nashik, 422123,  
Maharashtra, India.  
TEL:+91-11- 4507 6293 (DELHI)  
TEL:+91-22-2781 3385 (MUMBAI)

**3 博能传动(美国)有限公司**  
1250 E 222nd Euclid, OH 44117,United Staes  
TEL: 1-216-618-3099  
TEL: 1-216-618-0138

**4 博能传动(沈阳)有限公司**  
沈阳市沈北新区太平洋工业城A区A73-6号 110013  
TEL: 024-31271571

**5 博能传动(天津)有限公司**  
天津市北辰区双海道6号宏鹏工业园7号车间 300021  
TEL: 022-26929556

**6 博能传动(潍坊)有限公司**  
山东省潍坊市安丘市经济开发区汶水路与  
昆仑大街交叉口往北100米路东1号车间 261000  
TEL: 0536-2141166

**7 博能传动(开封)有限公司**  
河南省开封市宋城路四大街11号海神机械院内五号厂房 475000  
TEL: 0371-23335238

**8 博能传动(长沙)有限公司**  
长沙市望城经济开发区普瑞大道1288号 410205  
TEL: 0731-88386958

**1 BONENG TRANSMISSION(SUZHOU)CO.,LTD.**  
No. 100, Ruyuan Road, Xiangcheng District, 215131  
Suzhou, Jiangsu Province, China  
TEL: 0512-66189662

**2 BONENG TRANSMISSION(INDIA)PVT.LTD**  
Plot No. E-10/3, MIDC sinnar (Malegaon)  
Industrial Area, Nashik, 422123,  
Maharashtra, India.  
TEL:+91-11- 4507 6293 (DELHI)  
TEL:+91-22-2781 3385 (MUMBAI)

**3 BONENG TRANSMISSION(USA)LLC.**  
1250 E 222nd Euclid, OH 44117,United Staes  
TEL: 1-216-618-3099  
TEL: 1-216-618-0138

**4 BONENG TRANSMISSION(SHENYNG)CO.,LTD.**  
No. A73-6, Area A, Pacific Industrial City, Shenbei 110013  
New District, Shenyang, Liaoning Province, China  
TEL: 024-31271571

**5 BONENG TRANSMISSION(TIANJIN)CO.,LTD.**  
7th Workshop, Hongpeng Industrial Park, No.6  
Shuanghai Road, Beichen District, Tianjin City,China 300021  
TEL: 022-26929556

**6 BONENG TRANSMISSION(WEIFANG)CO.,LTD.**  
1st Workshop, Economic Development Zone, Anqiu, 261000  
Weifang City, Shandong Province, China  
TEL: 0536-2141166

**7 BONENG TRANSMISSION(KAIFENG)CO.,LTD.**  
5th Workshop, Haishen Machinery, No.11, Fourth  
Street, Songcheng Road,New District, Kaifeng City,  
Henan Province, China 475000  
TEL: 0371-23335238

**8 BONENG TRANSMISSION(CHANGSHA)CO.,LTD.**  
No. 1288 Puri Avenue, Wangcheng Economic Development  
Zone, Changsha City, Hunan Province, China 410205  
TEL: 0731-88386958

**BONENG**

**BONENG**